

PUB No. Title
AI AII20590 2000 S2000 ENGINE BLOCK HEATER

Issued
08/25/99

H HONDA INSTALLATION INSTRUCTIONS	Accessory ENGINE BLOCK HEATER P/N 08T44-S2A-100	Application 2000 S2000	Publications No. AII 20590
			Issue Date AUG 1999

PARTS LIST

Engine block heater



Aluminium washer



Heater harness



Protective cap

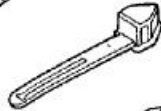

4 Short wire ties



3 Long wire tie



Bracket



2 Wire ties with clip

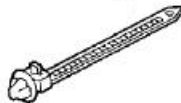

TOOLS AND SUPPLIES REQUIRED

10 mm and 12 mm Combination wrenches

19 mm and 24 mm Sockets

Wire cutters

Ratchet

Torque wrench

Drain pan

Tape measure

Coolant (Genuine Honda Antifreeze/Coolant only, in a 50/50 mixture with water)

NOTE:

- Always use Genuine Honda Antifreeze/Coolant. Using a non-Honda coolant can result in corrosion, causing the cooling system to malfunction or fail.
- To avoid burning out the element, do not operate the engine block heater before it is installed in the vehicle and before you add coolant.

INSTALLATION

Customer Information: The information in this installation instruction is intended for use only by skilled technicians who have the proper tools, equipment, and training to correctly and safely add equipment to your car. These procedures should not be attempted by "do-it-yourselfers."

1. Allow the engine and all cooling system components to cool down.
2. Place a clean drain pan under the radiator drain plug, then remove the drain plug from the bottom of the radiator to drain the coolant. Remove the radiator cap to increase the flow.

NOTICE Radiator coolant will damage paint. Quickly rinse any spilled coolant from painted surfaces.

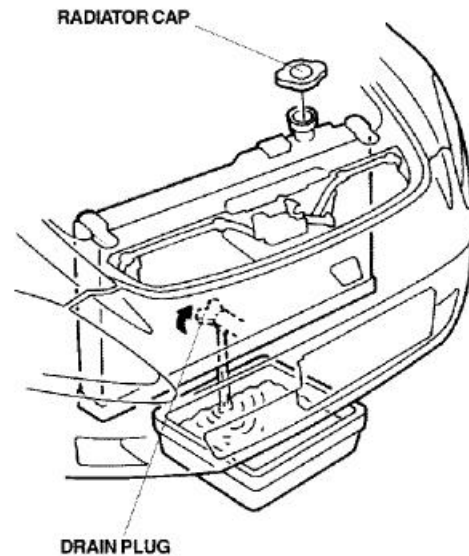

PUB No. Title
AI AII20590 2000 S2000 ENGINE BLOCK HEATER

Issued
08/25/99

3. Locate and remove the engine block drain bolt and washer. Coolant remaining in the engine jackets flows out of the bolt hole when the bolt is removed. (Retain the bolt in case the block heater is removed.)

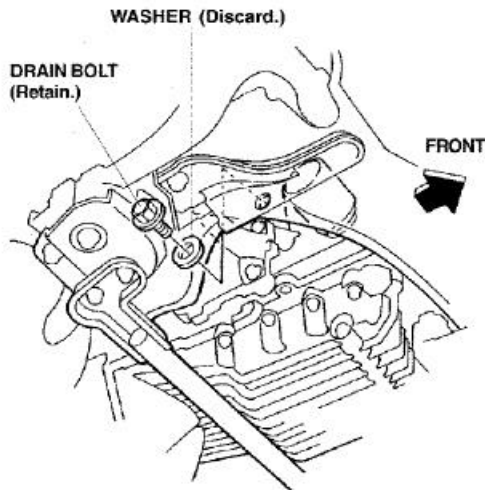

4. Install the new aluminium washer and the engine block heater into the bolt hole using a 24 mm socket and a torque wrench. Torque the engine block heater to 60 N•m (44 lb-ft).

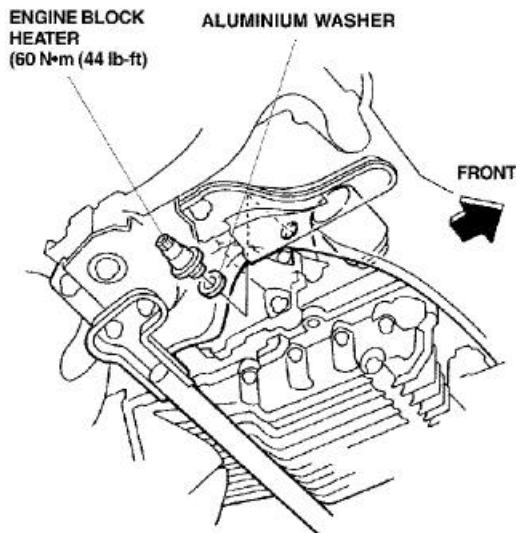

5. Attach the two wire ties with clip to the heater harness in the areas shown.

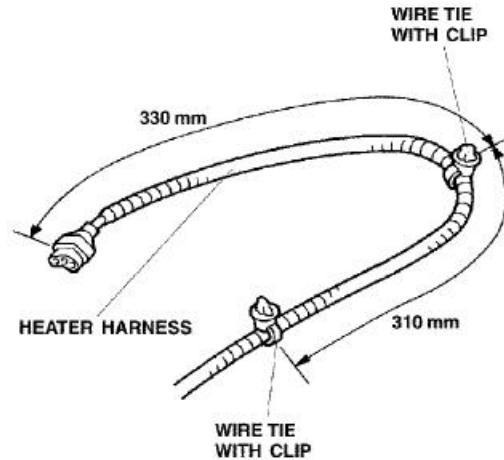

PUB No. Title
AI AII20590 2000 S2000 ENGINE BLOCK HEATER

Issued
08/25/99

6. Plug the connector of the heater harness into the engine block heater.

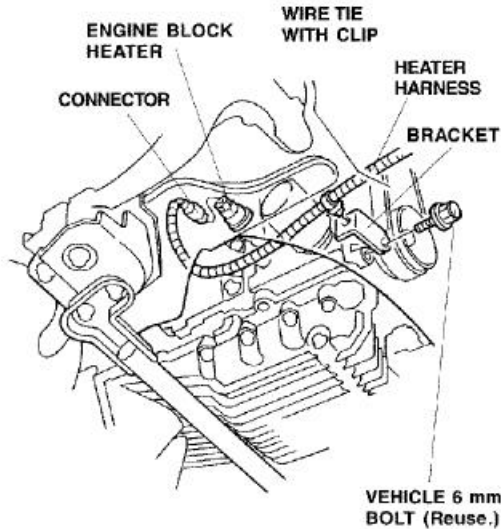

7. Remove the 6 mm bolt fastening the engine front cover and attach the bracket from the kit with this 6 mm bolt. Tighten the 6 mm bolt securely.

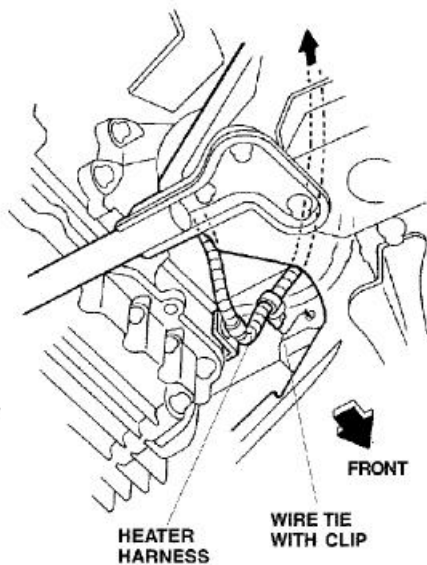

8. Route the heater harness as shown, and push the clips of the two wire ties attached in step 5 into the holes in the bracket and cross member.

9. Continue routing the heater harness along the vehicle harness as shown.

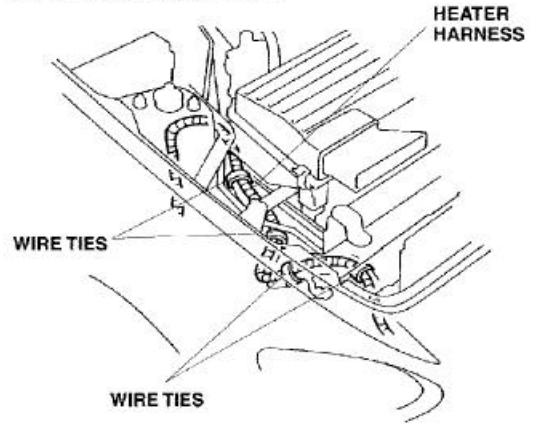

10. Secure the heater harness to the vehicle harness with the four wire ties in the areas shown.
11. Attach the protective cap to the front bumper grille, and plug the connector of the heater harness into the protective cap.

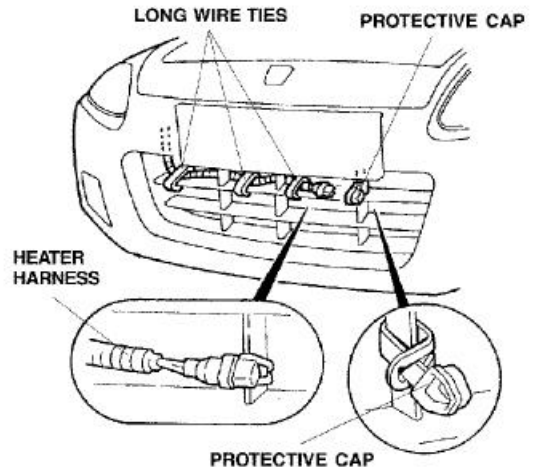

12. Secure the heater harness to the front bumper grille with three long wire ties.
13. Reinstall the radiator drain plug.
14. Fill the system with the recommended coolant.
 - Follow the instructions described in the service manual when filling the system with the recommended coolant.

15. Check the coolant reservoir for correct level and signs of leakage. Repair as necessary.
16. Check that the heater harness is routed properly and all connectors are plugged in.
17. Put the drain bolt (removed in step 3) in the glove box.