



INSTALLATION INSTRUCTIONS

Accessory
HOOD AIR DEFLECTOR
P/N 08P47-TP6-100

Application
2010 ACCORD
CROSSTOUR

Publications No.
All 41948

Issue Date
NOV 2009

PARTS LIST

Hood air deflector

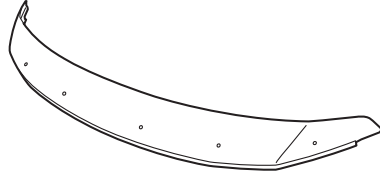

2 Brackets A

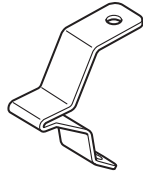

2 Brackets B

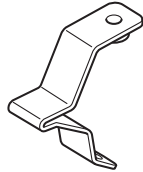

Right bracket C



Left bracket C



Center stopper

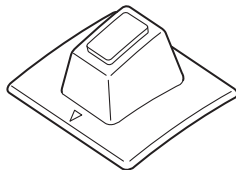

4 Clips A



2 Clips B

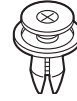

2 Screws



2 Truss screws



2 Grommets



2 Collars



Warning label

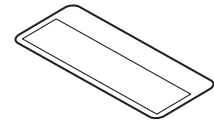

3 Alcohol swabs

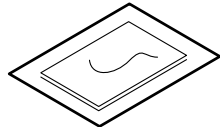

4 Protective tapes



Template

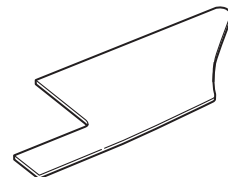

TOOLS AND SUPPLIES REQUIRED

Phillips screwdriver
Felt-tip pen
Tape measure
Masking tape

Illustration of the Hood Air Deflector Installed on the Vehicle

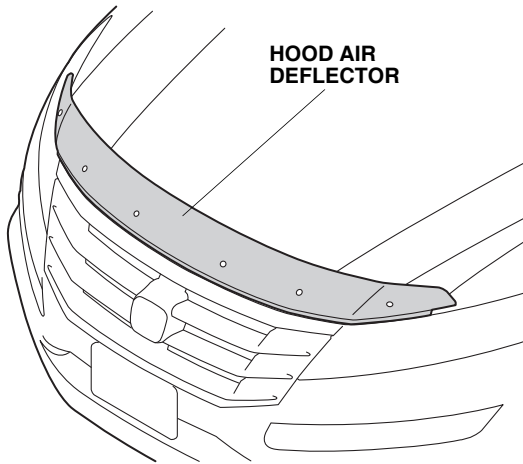

INSTALLATION

Customer Information: The information in this installation instruction is intended for use only by skilled technicians who have the proper tools, equipment, and training to correctly and safely add equipment to your vehicle. These procedures should not be attempted by “do-it-yourselfers.”

NOTE:

- Do not damage the body paint finish when you install the hood air deflector.
- This hood air deflector kit should be installed only if the ambient air temperature is above 15°C (60°F).
- To allow the adhesive to cure, do not wash the vehicle for 24 hours. Please advise the customer.
- The hood air deflector cannot be installed with nose mask.

Installing the Hood Air Deflector

1. Using the front “H” emblem, locate the center of the hood. Measure up 28 mm from the edge of the hood, and clean the area where the center stopper will attach with an alcohol swab.

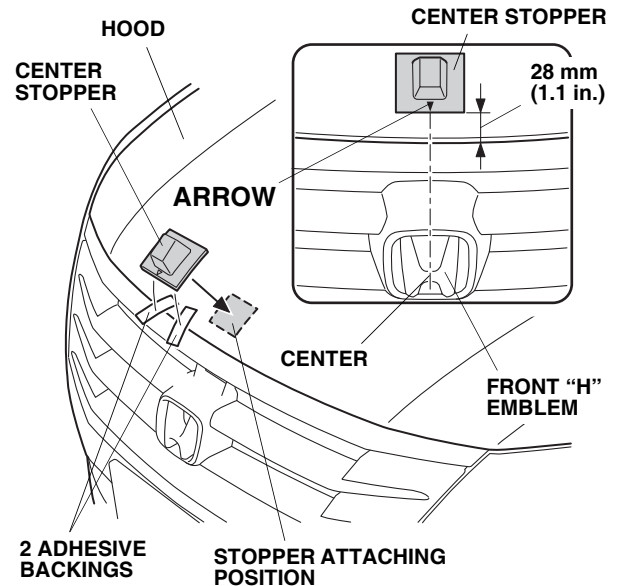

2. Remove two adhesive backings from the center stopper, and attach it to the hood at the marked location with the arrow facing down.
3. Open the hood. Locate the two square holes in the hood. Push one grommet into each square hole.

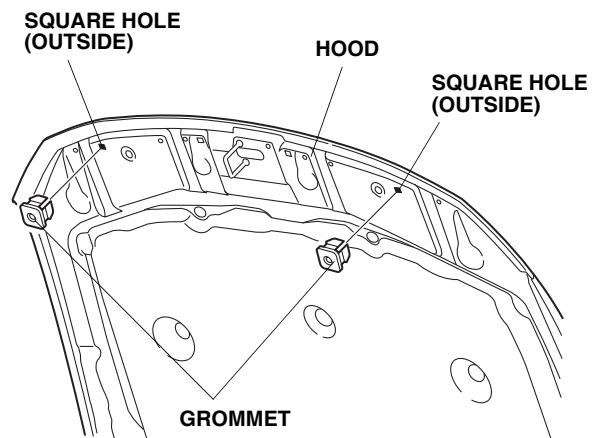

- Using an alcohol swab, thoroughly clean the hood where the protective tapes will attach.

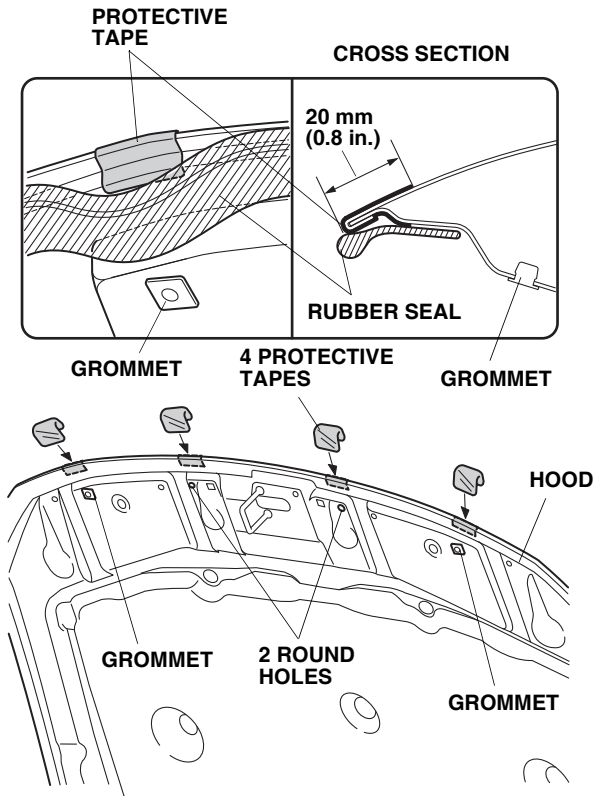

- Remove the adhesive backings from the protective tapes and attach four protective tapes around the front of the hood under the rubber seal. Use the two grommets and the two round holes as reference. Wrap approx. 20 mm (0.8 in.) of the protective tape around the lip of the hood at each of the four locations.

- Under the hood rubber seal, position two brackets B over the protective tapes at the outer locations, and loosely install one truss screw through each bracket. Under the hood rubber seal, position two brackets A over the protective tapes, and secure each one with clip B. Close the hood at the inner locations.

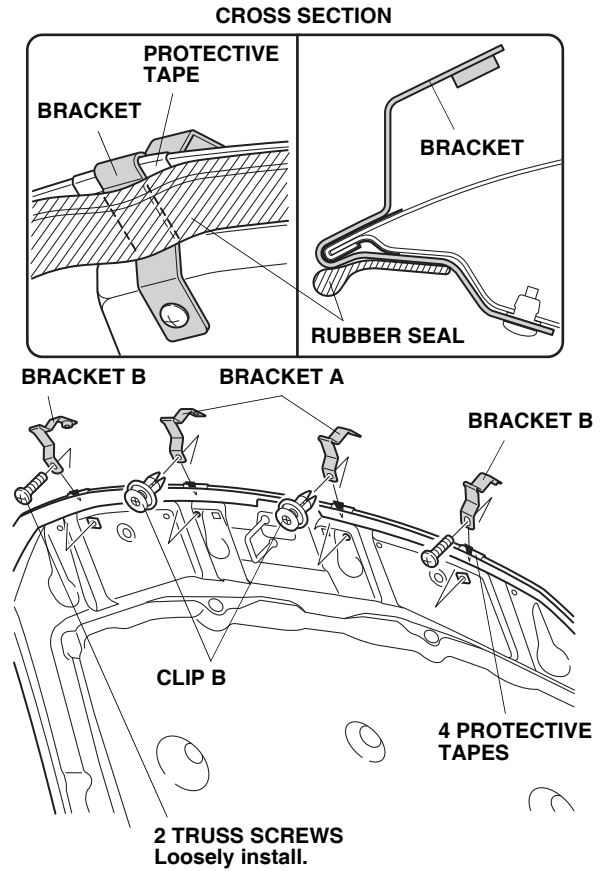

- Place the template on the left side of the hood with the "L" side up, and tape it in place. Using a felt-tip pen, mark on the hood as shown on the template.

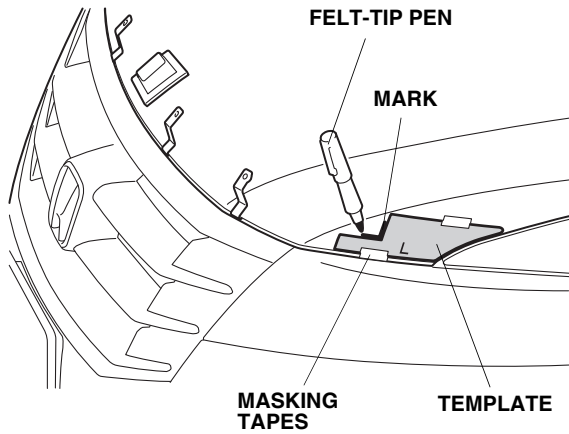

- Remove the template.
- Using an alcohol swab, thoroughly clean the area where the left bracket C will attach. Remove the adhesive backing from the left bracket C and attach it to the mark made in step 7. Make sure the left bracket C is installed in the correct direction.

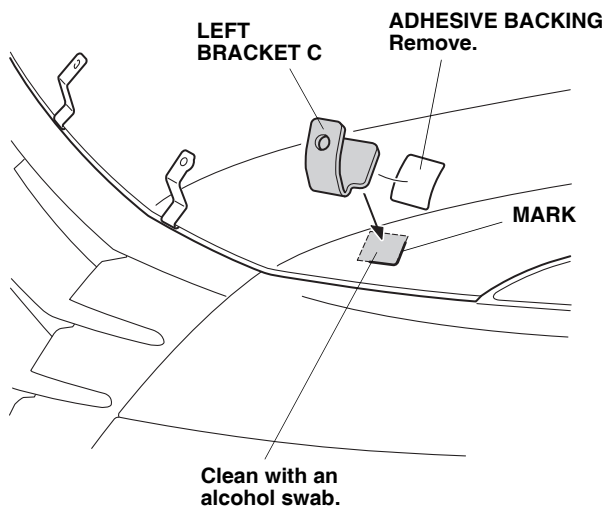

- Turn the template over and repeat steps 7 thru 9 to install the right bracket C on the right side of the vehicle.

- Align the holes in hood air deflector with the brackets A, B, and C. Install the hood air deflector with two screws, two collars and four clips A. Do not tighten at this time.

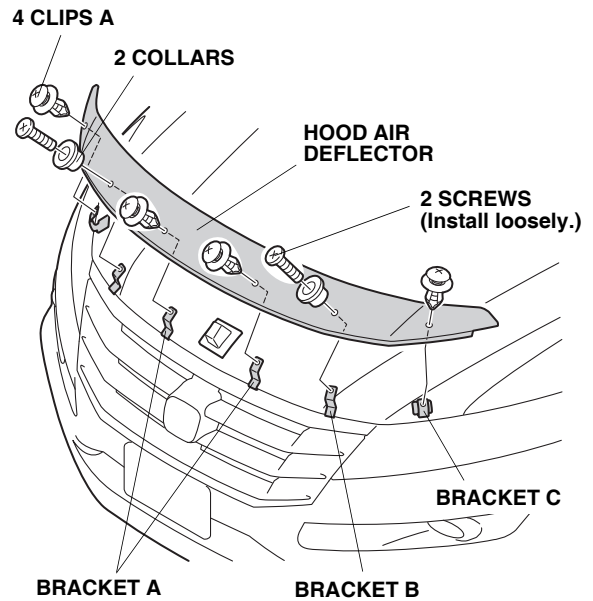

- Insert the large end of the template between the hood and the hood air deflector to unfold the molding as shown. Remove the template by pulling it towards you.

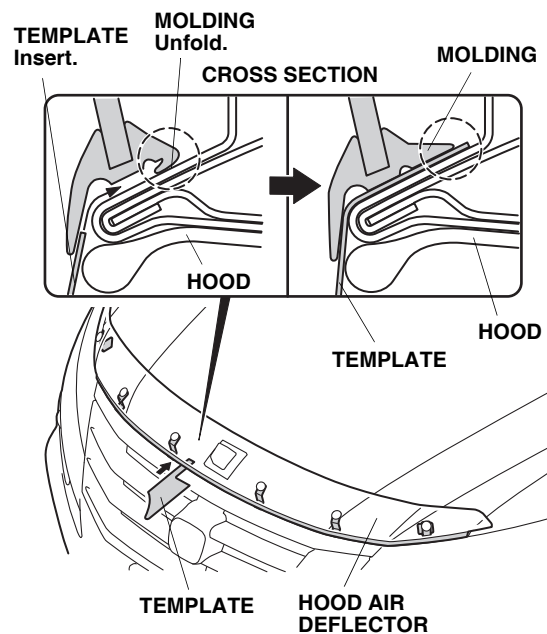

- Open the hood. Tighten the two truss screws and the two air deflector screws you loosely installed in steps 6 and 11.

- 14. Using an alcohol swab, thoroughly clean the hood where the warning label will attach.

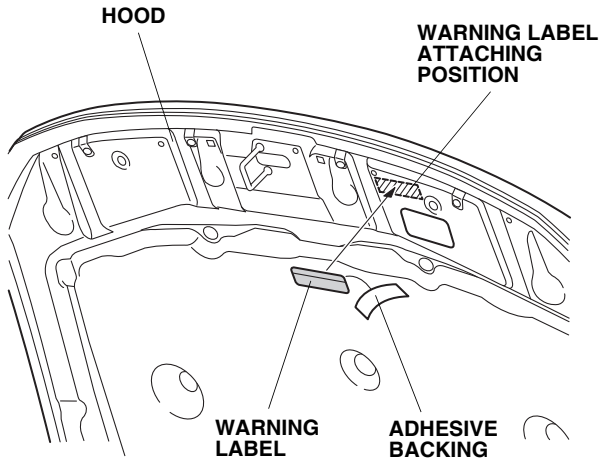

- 15. Apply the warning label to the hood in the area shown.