



INSTALLATION INSTRUCTIONS

Accessory
ALL SEASON FLOOR MATS

Application
2009 PILOT

Publications No.
All 39413
Issue Date
MAY 2008

Put this information in the glove box with the vehicle owner's manual.

PARTS LIST

All Season Floor Mat Set
P/N 08P13-SZA-100

Driver's side front floor mat

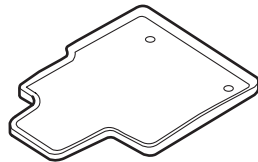

Passenger's side front floor mat

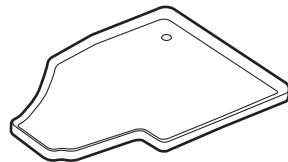

Second row floor mat

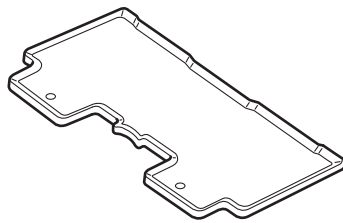

Third row floor mat

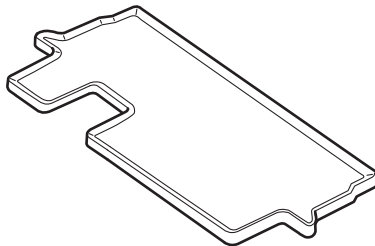

Third Row All Season Floor Mat
P/N 08P13-SZA-100B

Third row floor mat

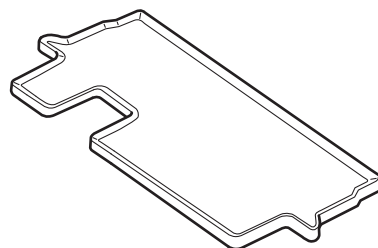

INSTALLATION

NOTE:

- Before installing, identify each floor mat.
- Remove the standard floor mats before installing these floor mats.
- Do not put additional mats on top of the anchored mat. Additional mats may slide forward and possibly interfere with the pedals.

Installing the All Season Floor Mats

1. Install the driver's side front floor mat by placing the two mat grommets over the two anchors on the floor carpet.

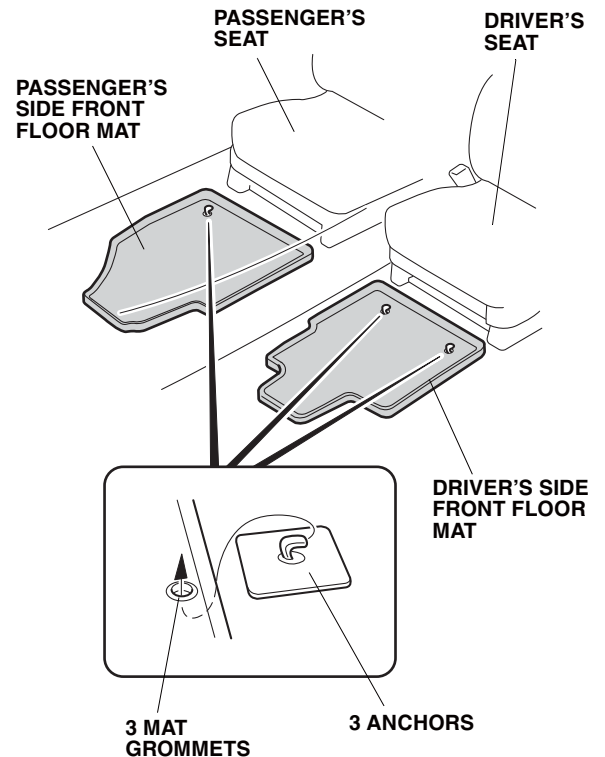

2. Install the passenger's side front floor mat by placing the mat grommet over the anchor on the floor carpet.

3. Install the second row floor mat by placing the two mat grommets over the two anchors on the floor carpet.

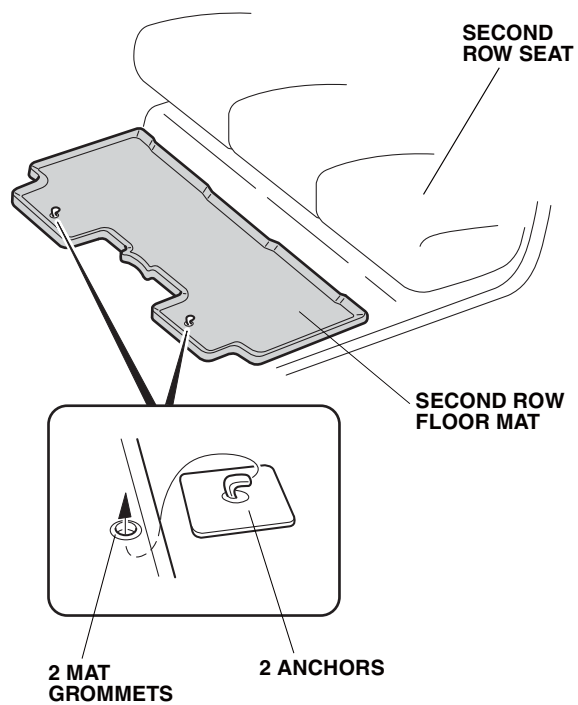

4. Install the third row floor mat on the floor carpet.

