



INSTALLATION INSTRUCTIONS

Accessory
AUTOMATIC DAY/NIGHT MIRROR WITH COMPASS
P/N 08V03-SDA-102

Application
ACCORD
2- AND 4-DOOR

Publications No.
All 25715-26305
Issue Date
NOV 2003

PARTS LIST

Day/night mirror

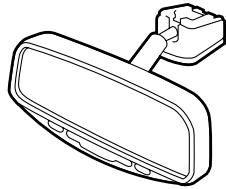

Upper cover

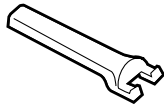

Lower cover

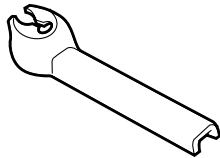

Day/night mirror harness

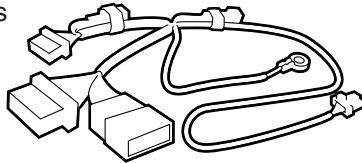

Mirror harness



9 Wire ties



5 Cushion tapes

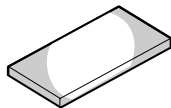

Owner's Manual

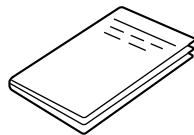

TOOLS AND SUPPLIES REQUIRED

- Phillips screwdriver
- Flat-tip screwdriver
- Small flat-tip screwdriver
- 10 mm Combination wrench
- Diagonal cutters
- Ratchet
- 8 mm and 10 mm Sockets
- Drill
- 7 mm Drill bit
- T25 Torx bit
- Torque wrench
- Isopropyl alcohol
- Shop towel
- Piece of steel wire
- Electrical tape
- Eye protection (face shield, safety goggles, etc.)
- Tape measure

Illustration of the Day/Night Mirror Installed on the Vehicle

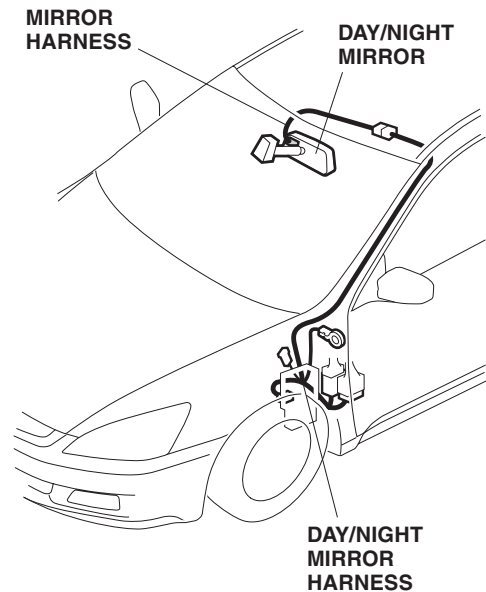

INSTALLATION

Customer Information: The information in this installation instruction is intended for use only by skilled technicians who have the proper tools, equipment, and training to correctly and safely add equipment to your vehicle. These procedures should not be attempted by "do-it-yourselfers."

1. Make sure you have the anti-theft code for the radio, then write down the frequencies for the preset buttons.
2. Disconnect the negative cable from the battery.
3. Remove the left and right lens front the roof console (six retaining tabs).

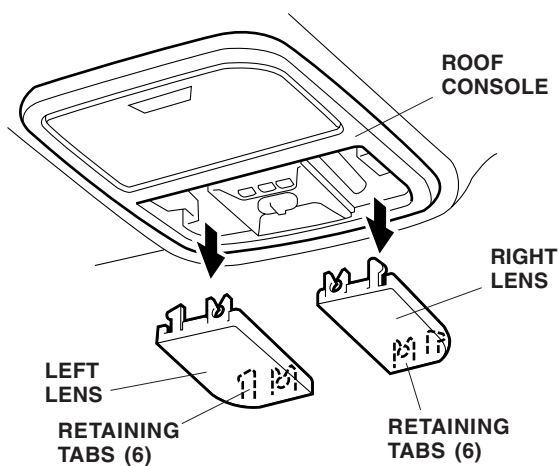

4. Remove the roof console (four bolts, and unplug two connectors).

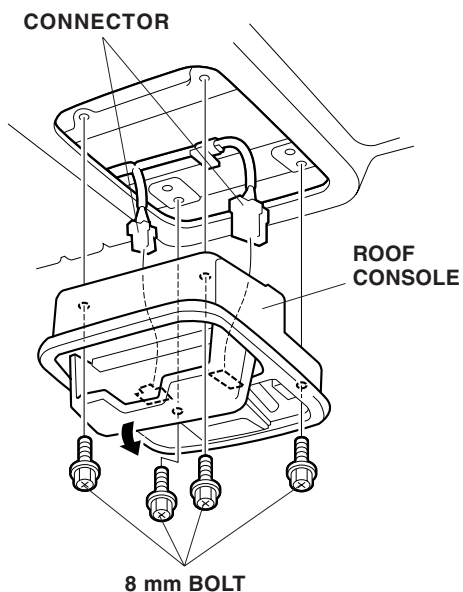

5. Remove the sunvisor holders. Using a flat-tip screwdriver, push the hook, and turn the holder 90°, then pull it out.

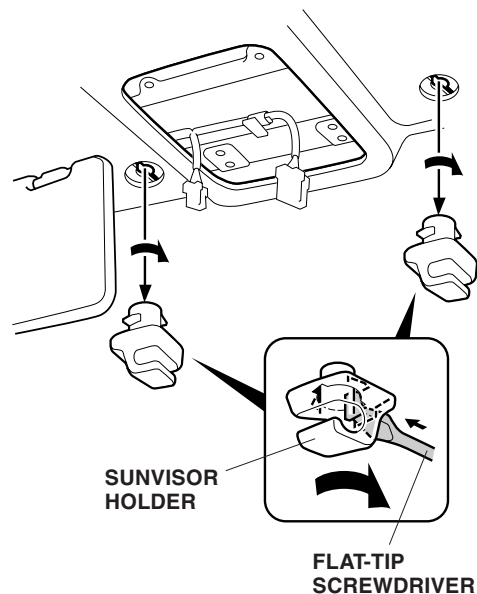

6. Remove the cap from the left sunvisor (four retaining tabs).

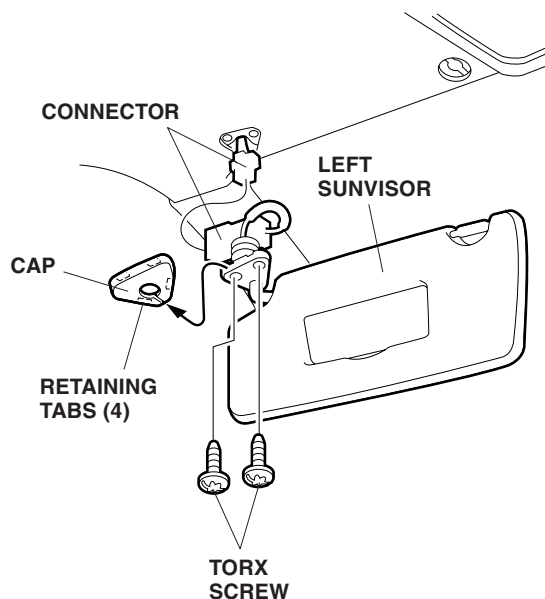

7. Remove the left sunvisor (two T25 Torx screws and unplug the connector).

8. Remove the weatherstrip from the opening edge of front door in the area shown, then remove the left front pillar trim (with curtain side airbag: one pin and one clip; without curtain side airbag: two clips).

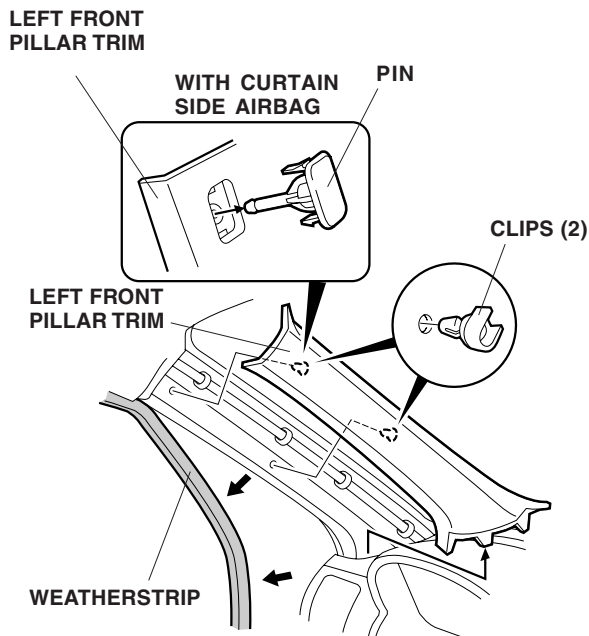

9. Remove the driver's dashboard lower cover:
 - Remove the self-tapping screw.
 - Release the four clips on the left side first by pulling out on the driver's dashboard lower cover.
 - After releasing the four clips, insert the flat-tip screwdriver between the clip and the dashboard frame. Gently twist the screwdriver to release the clip.
 - Release the two clips on the right side last.
 - Unplug the vehicle connector, and remove the lower cover.

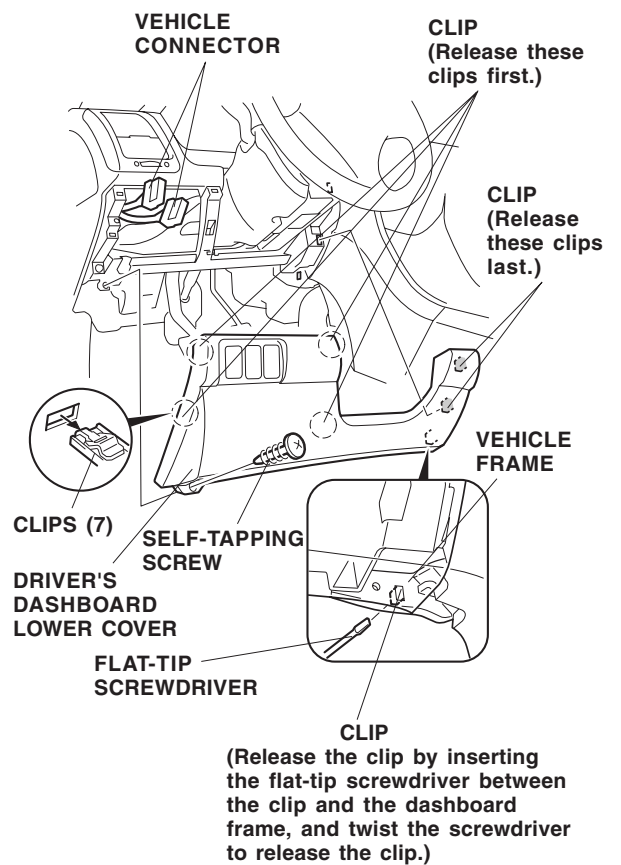

10. If equipped, remove the driver's dashboard under cover (release the three retaining clips, one pin, and one holder).

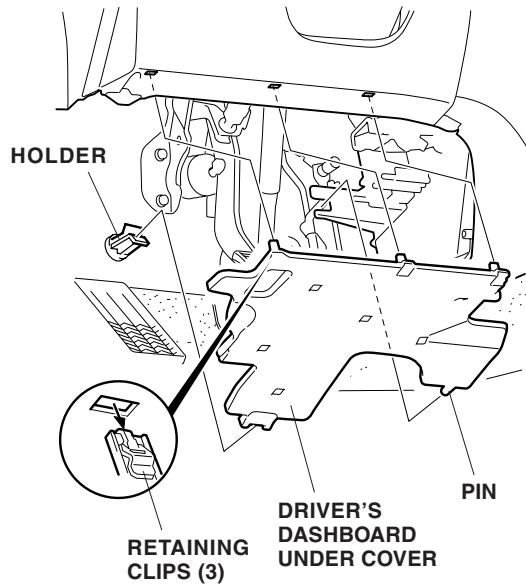

11. Remove the rearview mirror from the holder by rotating the stay clockwise.

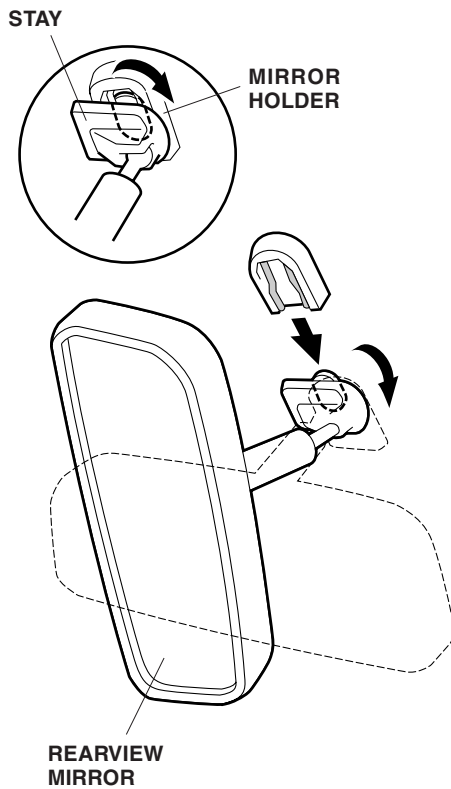

12. Replace the spring as needed. Slide the day/night mirror stay onto the mirror holder, then turn the mirror stay counterclockwise as shown.

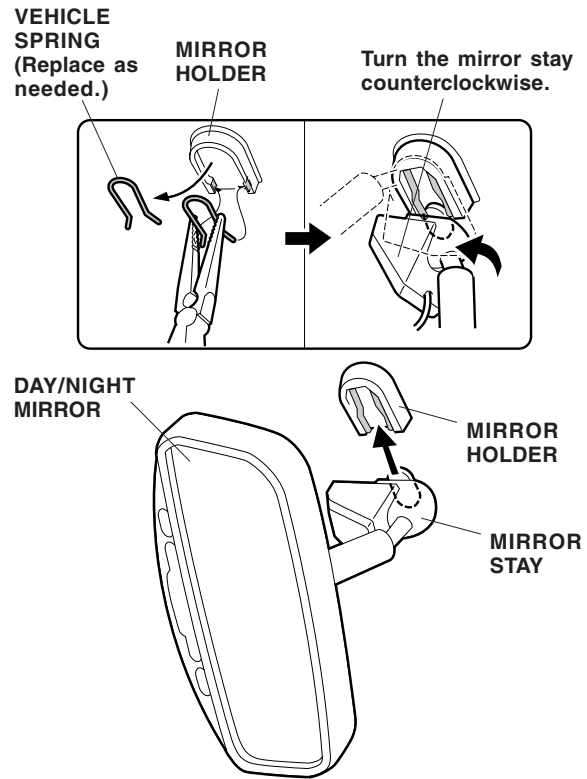

13. Plug the mirror harness 7-pin connector into the rear of the mirror, then route the 3-pin connector up and out through the console opening in the roof lining as shown.

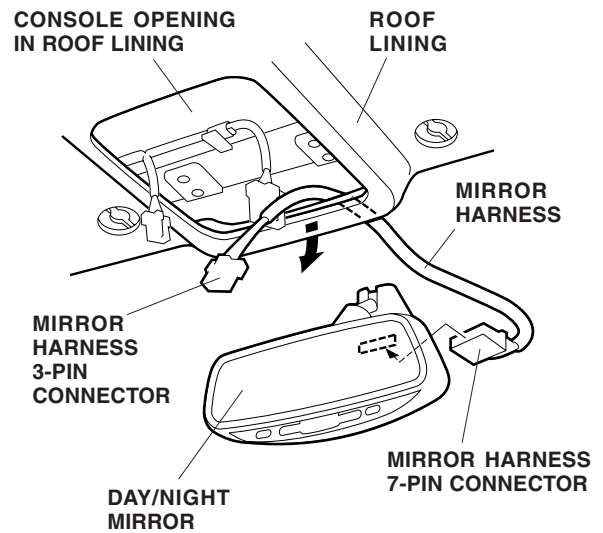

14. On the lower mirror cover, measure and cut off the ribs shown.

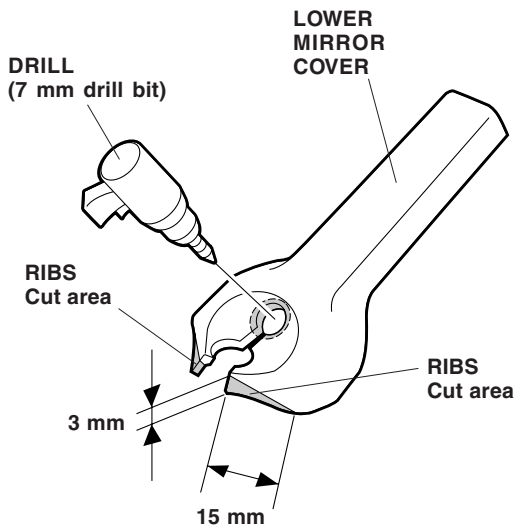

15. While wearing eye protection, drill a 7 mm hole through the existing hole on the lower cover as shown.
16. Measure the mirror harness in the area shown. Slide the end of the upper cover into the lower cover, then route the mirror harness through the grooves in the covers. Attach the lower cover to the stay of the mirror.

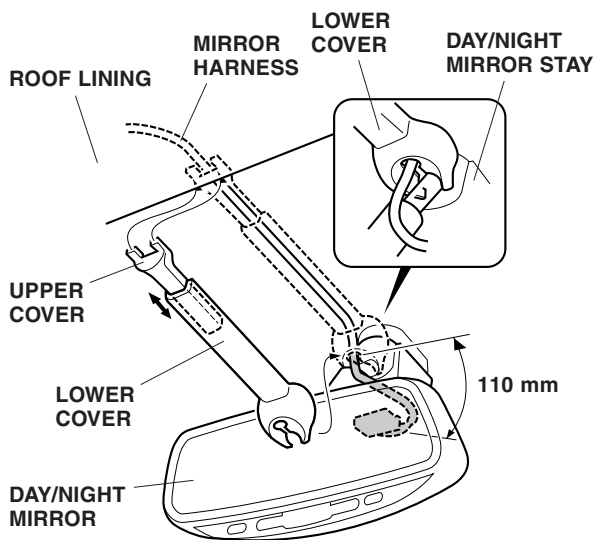

17. Attach a piece of steel wire to the day/night mirror harness 3-pin connector, and wrap electrical tape around the wire and the day/night mirror harness. Pull the 3-pin connector up along the instrument panel side bracket and out through the clearance between the left front pillar and the instrument panel.

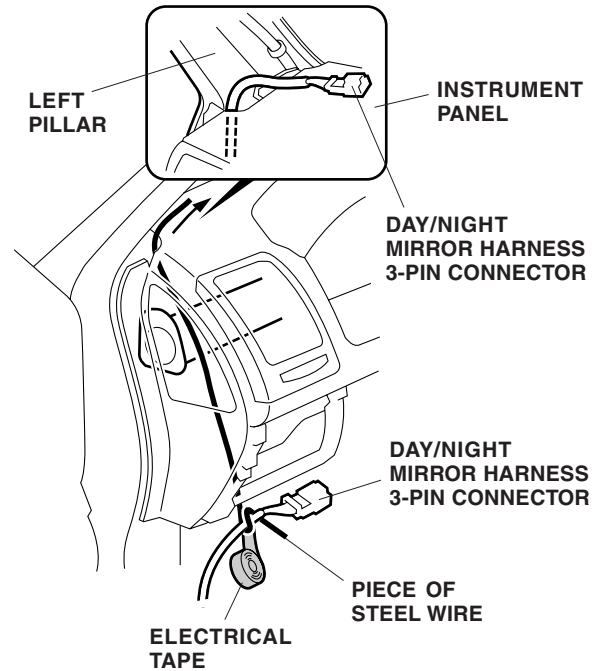

18. Remove the electrical tape and the wire from the day/night mirror harness.

- Route the day/night mirror harness 3-pin connector up along the left front pillar and out through the roof console opening along side the vehicle behind the roof lining.

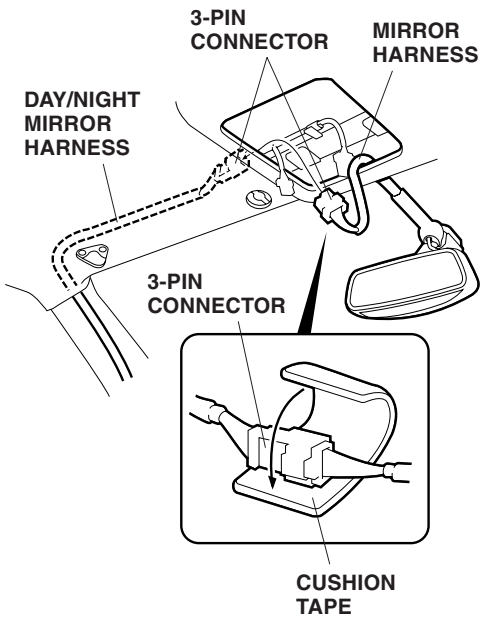

- Connect the day/night mirror harness 3-pin connector to the mirror harness 3-pin connector. Wrap one cushion tape around the connectors.
- Inside the roof lining, secure the mirror harness to the vehicle harness with the one wire tie. Secure the day/night mirror harness on the vehicle panel with two cushion tapes.

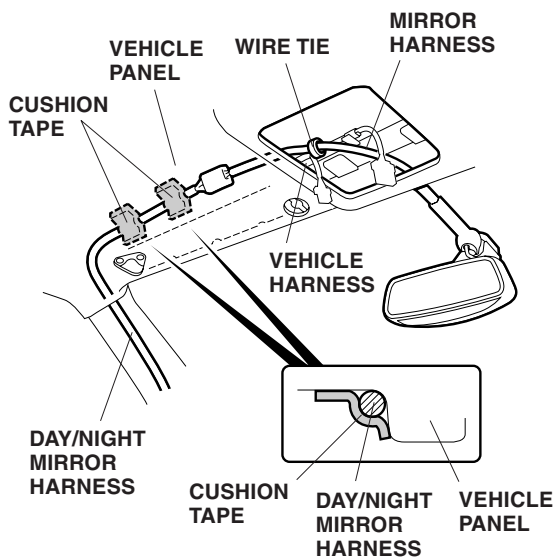

- Secure the day/night mirror harness and the mirror harness to the vehicle harness with four wire ties.

With Vehicle Harness:

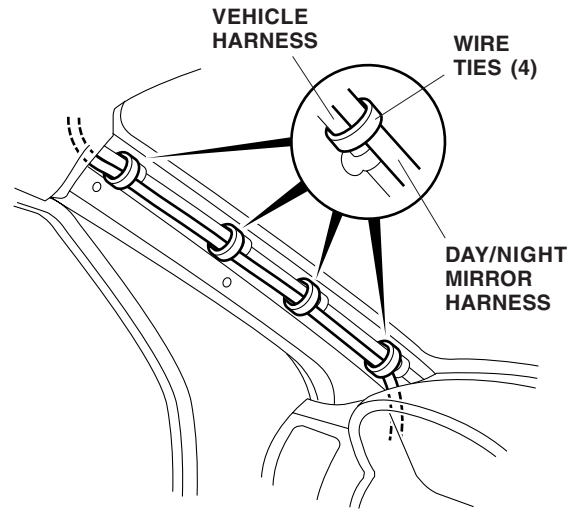

With Vehicle Harness and i-VES:

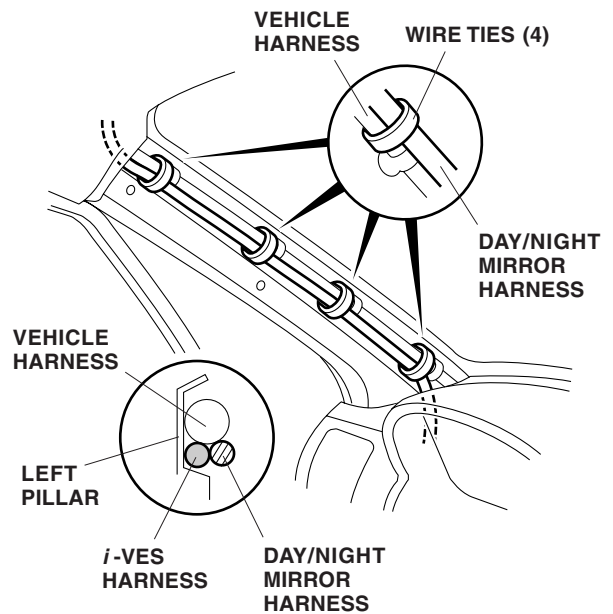

Without Vehicle Harness:

- Using isopropyl alcohol and a shop towel, thoroughly clean the areas where the cushion tape will attach. Cut two cushion tapes in half, then secure the day/night mirror harness to the left front pillar with the four half cushion tapes.

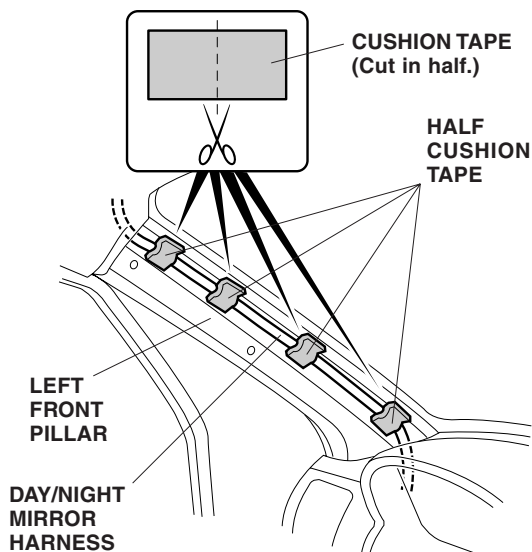

23. Plug the day/night mirror harness 6-pin connector into the fuse box located behind the kick panel.

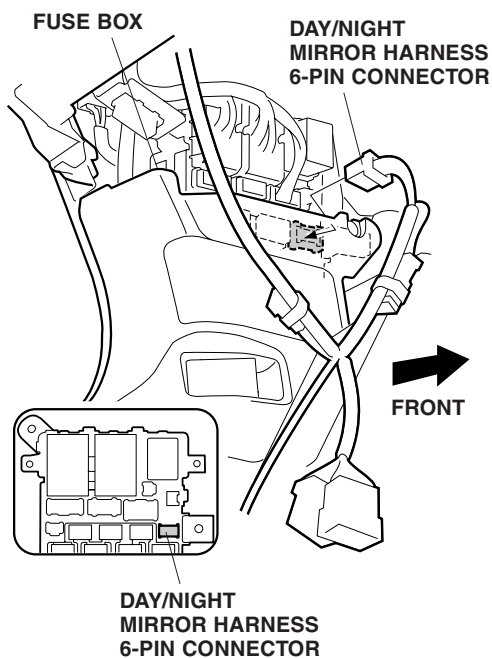

NOTE: If you are also installing another accessory that uses the 6-pin connector, remove the dummy connector from the 6-pin connector taped to the day/night harness. Connect the 6-pin connector from the other accessory harness into the 6-pin connector you just unplugged.

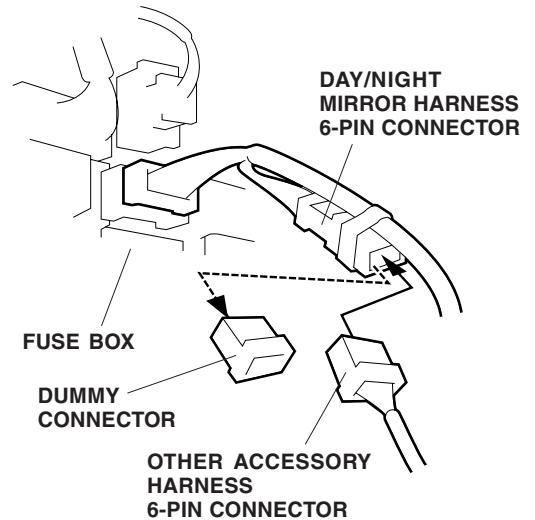

24. Unplug the vehicle 4-pin connector and the vehicle 24-pin connector. Connect the day/night mirror harness 24-pin connector in between the vehicle harness 24-pin connector.

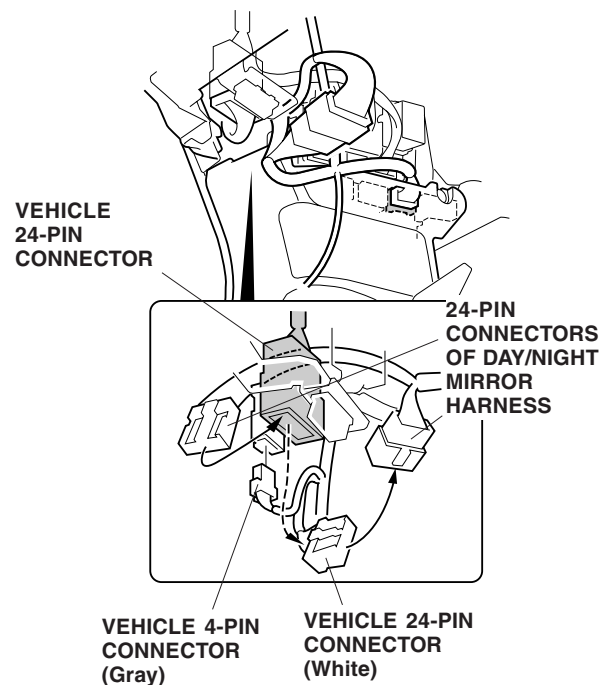

25. Reconnect the vehicle 4-pin connector.

26. Loosen the ground bolt, and slide the ground terminal of the day/night mirror harness with onto the ground bolt. Then retighten the ground bolt.

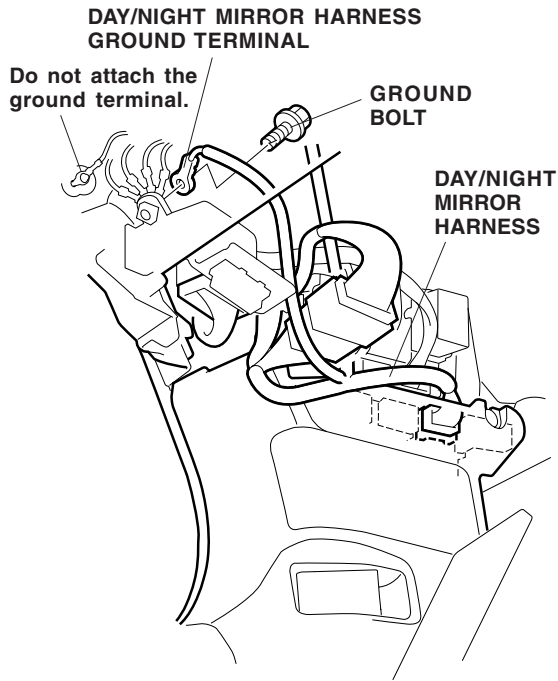

27. Secure the day/night mirror harness to the vehicle harness with two wire ties.

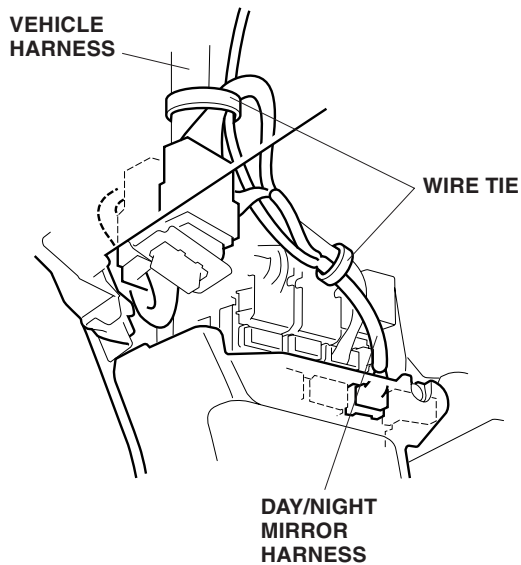

28. Check that all wire harnesses and cables are routed properly and that all connectors are plugged in.
29. Reinstall all removed parts. Check that all clips and fasteners are installed securely.
30. Reconnect the negative cable to the battery.
31. Enter the customer's radio anti-theft code, and reset the radio station presets.
32. Reset the clock.
33. Check the operation of the automatic day/night mirror according to the Owner's Manual supplied.

NOTE: Whenever the battery is disconnected, the driver's AUTO function is disabled.

34. Start the engine. Push down on the driver's window switch until the window is fully open.
35. Pull up on the driver's window switch fully to close the window completely, then hold the switch for 2 seconds or more.
36. Test the driver's window AUTO function.