



INSTALLATION INSTRUCTIONS

Accessory
DOOR EDGE GUARDS

Application
CR-V

Publications No.
All 23069
Issue Date
NOV 2001

PARTS LIST

Right front door edge guard

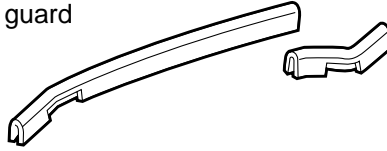

Left front door edge guard

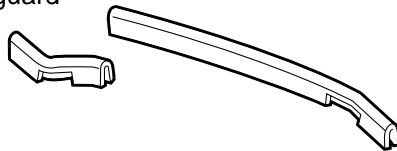

Right rear door edge guard

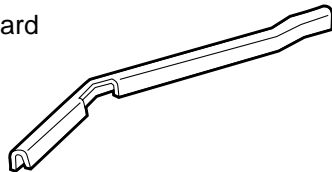

Left rear door edge guard

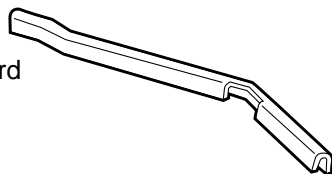

Seam sealant cutting tool

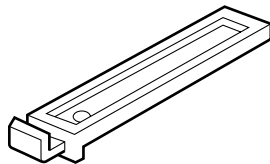

TOOLS AND SUPPLIES REQUIRED

- Rubber mallet
- Felt-tip pen
- Touch-up paint

INSTALLATION

Customer Information: The information in this instruction is intended for use only by skilled technicians who have the proper tools, equipment, and training to correctly and safely add equipment to your vehicle. These procedures should not be attempted by "do-it-yourselfers."

NOTE: The door edge guards will not fit on vehicles equipped with body side cladding.

1. Clean and wax the area to be covered with a high-quality paste wax.
2. Identify each door edge guard by holding it up to the door and matching its contour with the door edge.
3. Position each door edge guard against the inside edge of the front door using the bends for reference. Mark the sealant at the top and bottom ending points of each the door edge guard.

Front Door

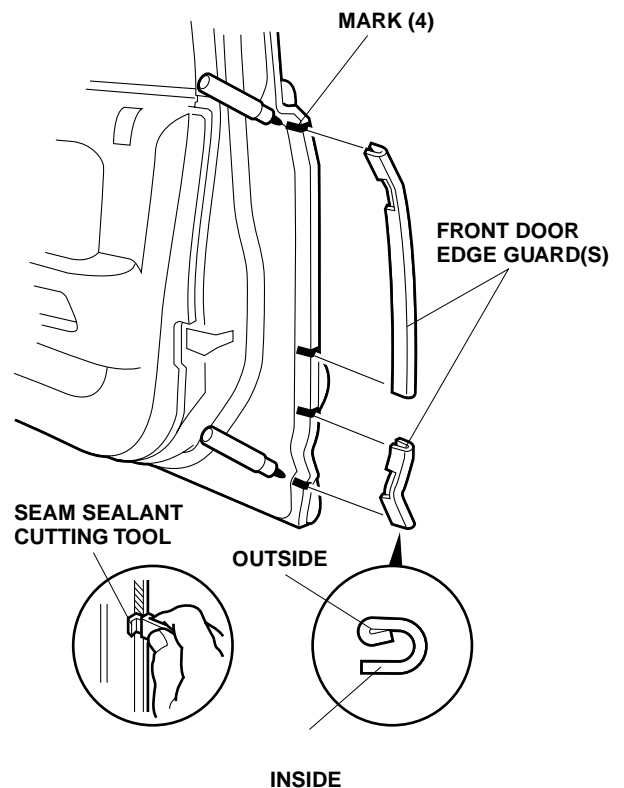

Rear Door

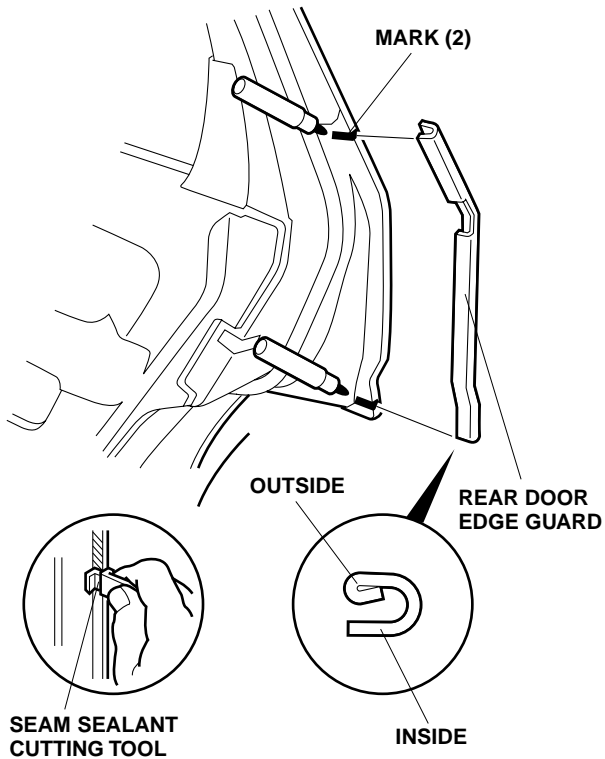

4. Position the cutting edge of the seam sealant cutting tool against the door edge and trim the seam sealant from mark to mark.

NOTE: The cutting tool only cuts in one direction. Move it upward on the right side of the vehicle and downward on the left side.

5. Apply touch-up paint to the door, and let it dry.

6. Position the door edge guard(s) on the door edge using the bends for reference, and tap into position with a series of light taps using a rubber mallet.

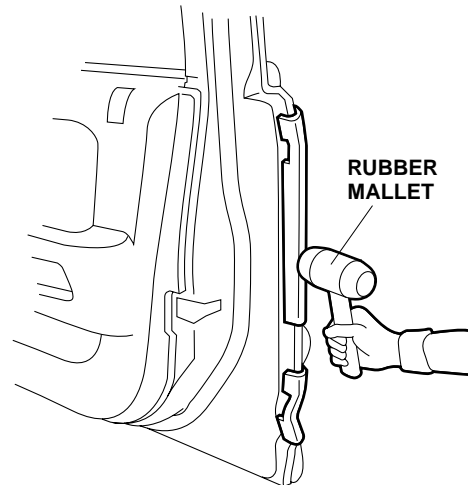
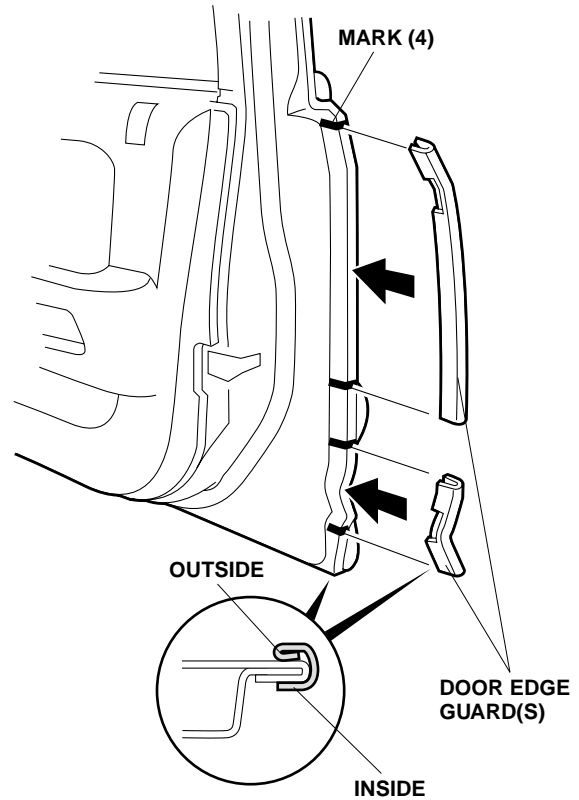

7. Repeat steps 1 through 6 to install the door edge guards on the other side of the vehicle.