



INSTALLATION INSTRUCTIONS

Accessory
SPLASH GUARDS
P/N 08P00-SCV-100C

Application
2011 ELEMENT

Publications No.
All 43505
Issue Date
OCT 2010

PARTS LIST

Left front splash guard

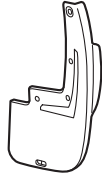

Right front splash guard



Left rear splash guard

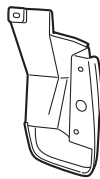

Right rear splash guard

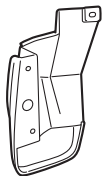

6 Self-tapping screws, 5 x 20 mm



2 Self-tapping screws, 5 x 30 mm



4 Clip nuts



2 Screw grommets



TOOLS AND SUPPLIES REQUIRED

Stubby Phillips screwdriver

Phillips screwdriver

INSTALLATION

NOTE: These installation instructions show the left splash guards being installed. The same procedure applies to installing the right splash guards.

Installing The Front Splash guards

1. Make sure the area to be covered is clean and has been waxed with a high-quality paste wax.
2. Turn the steering wheel fully counterclockwise.
3. Remove four self-tapping screws from the left front inner fender.

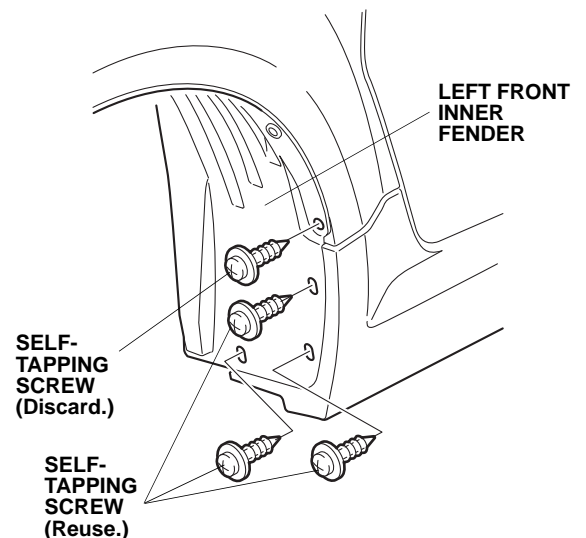

- Place the left front splash guard on the left inner fender as shown.

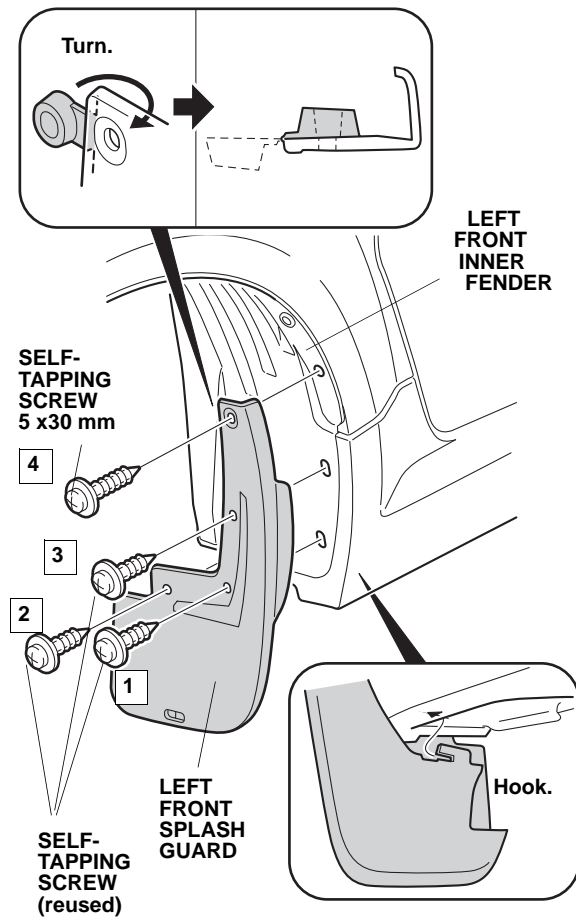

- Install the left front splash guard with one 5 x 30 mm self-tapping screw, and three self-tapping screws removed in step 3. Do not tighten the self-tapping screws yet.
- While holding the left front splash guard against the left front inner fender, tighten the self-tapping screws in the order shown.
- Turn the steering wheel all the way clockwise, and repeat steps 3 through 6 to install the right front splash guard.

Installing The Rear Splash Guards

- Using a self-tapping screw, pierce the two dimples in the rear bumper, then install two clip nuts over the holes.

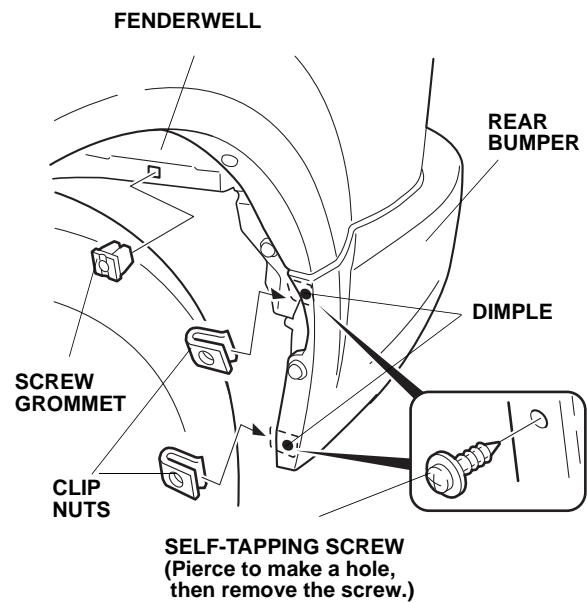

- Press one screw grommet into the hole in the fenderwell.
- Install the left rear splash guard on the rear bumper with three 5 x 20 mm self-tapping screws. Do not tighten the self-tapping screws yet.

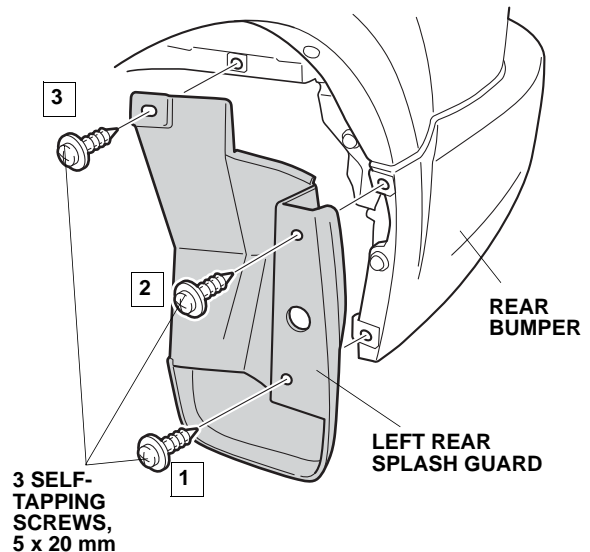

- While holding the left rear splash guard against the left rear bumper, tighten the self-tapping screws in the order shown.
- Repeat steps 8 through 11 to install the right rear splash guard.