



# INSTALLATION INSTRUCTIONS

Accessory <b>SPLASH GUARDS</b> P/N 08P00-SCV-100	Application <b>ELEMENT</b>	Publications No. <b>All 24313</b>
		Issue Date <b>DEC 2002</b>

## PARTS LIST

Left front splash guard

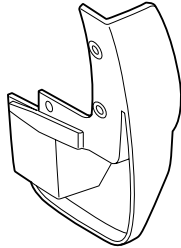

Right front splash guard

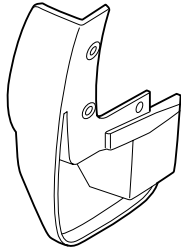

Left rear splash guard

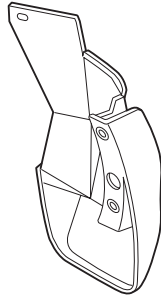

Right rear splash guard

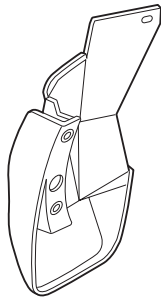

6 Self-tapping screws



4 Clip nuts



2 Screw grommets



## TOOLS REQUIRED

- Stubby Phillips screwdriver
- Phillips screwdriver

## INSTALLATION

**NOTE:** These installation instructions show the left splash guards being installed. The same procedure applies to installing the right splash guards.

### Installing The Front Splash guards

1. Make sure the area to be covered is clean and has been waxed with a high-quality paste wax.
2. Turn the steering wheel all the way counterclockwise.
3. Remove and retain the three self-tapping screws that fasten the left front inner fender to the front fender and fenderwell.

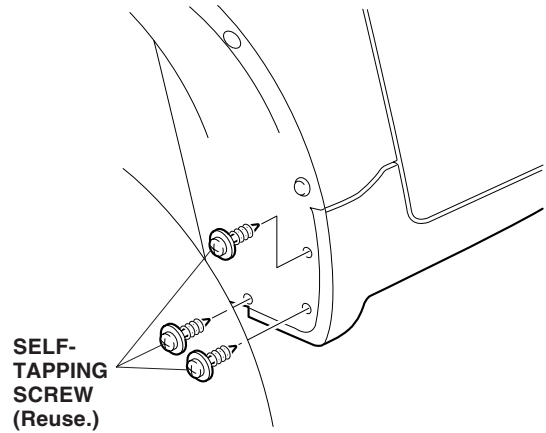

- Position the splash guard on the left front inner fender with the bottom portion under the inner fender. Loosely install the three self-tapping screws you removed. While holding the splash guard against the fender, tighten the self-tapping screws in the order shown.

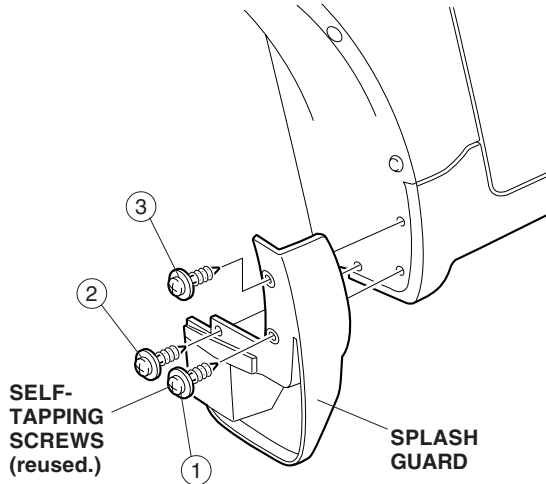

- Turn the steering wheel all the way clockwise, and repeat steps 3 and 4 to install the right front splash guard.

### Installing The Rear Splash Guards

- Slide two clip nuts over the dimpled areas of the rear bumper, and press one screw grommet into the hole in the fenderwell.

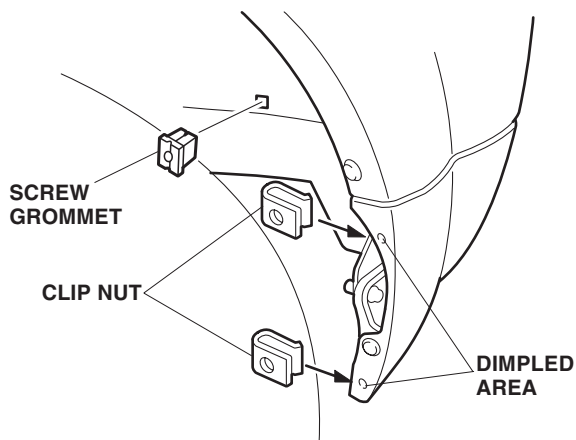

- Position the left rear splash guard on the fender and bumper and align the groove in the splash guard with the vehicle well nut, and loosely install three of the self-tapping screws provided. While holding the splash guard against the rear bumper, tighten the self-tapping screws in the order shown.

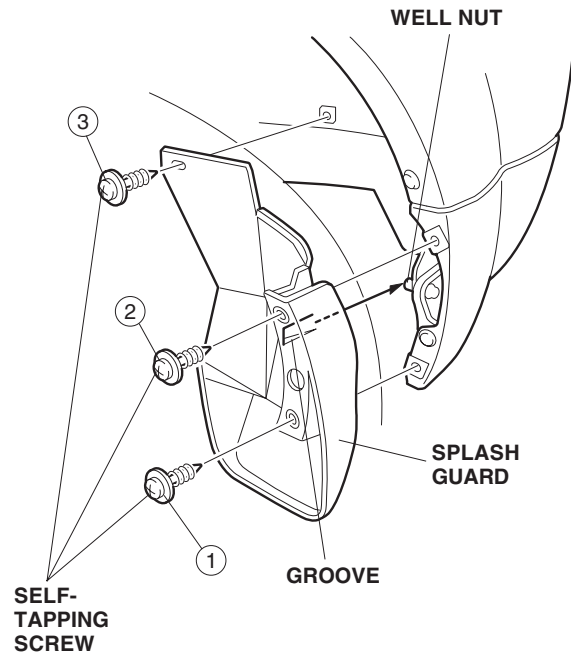

- Repeat steps 6 and 7 to install the right rear splash guard.