 HONDA INSTALLATION INSTRUCTIONS	Accessory	Application	Publications No.
	ROOF RACK P/N 08L02-S9V-100	PILOT (LX)	All 23625 Issue Date MAY 2002

PARTS LIST

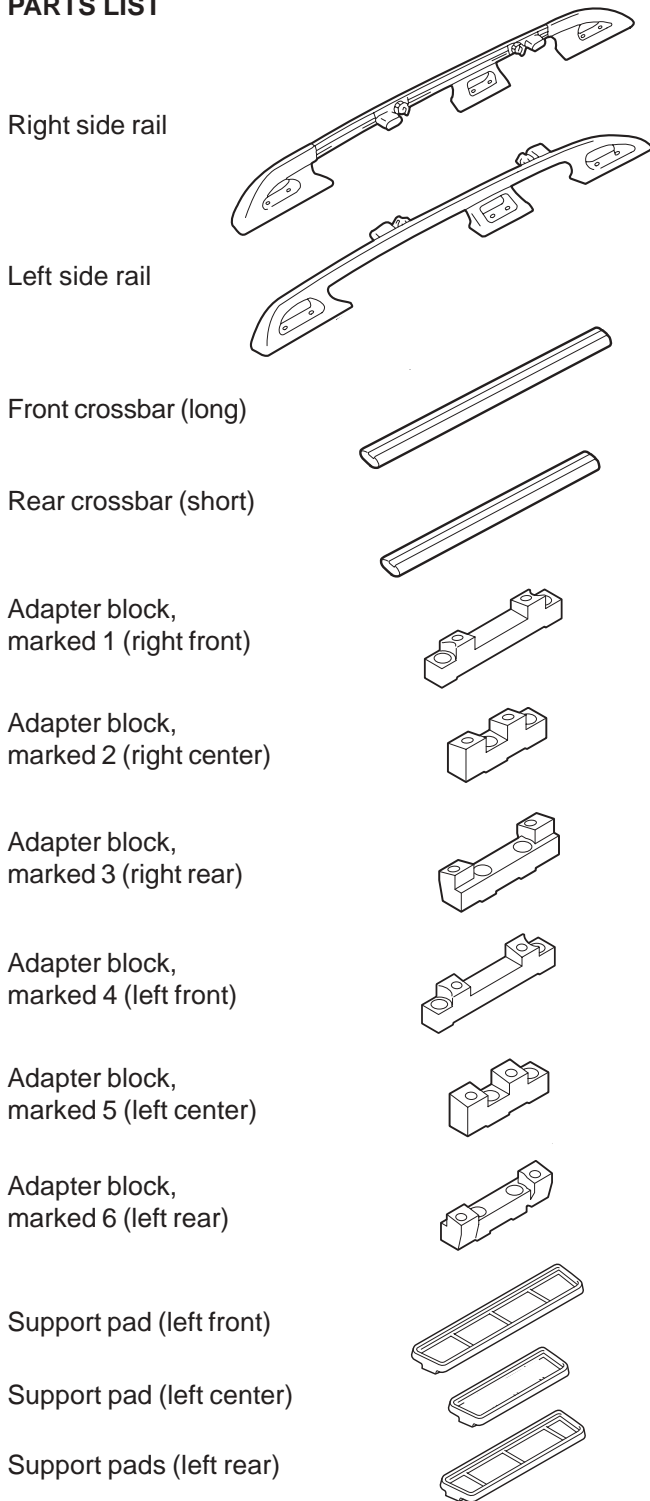

Support pad (right front)

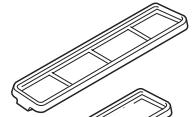

Support pad (right center)



Support pad (right rear)

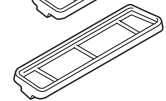

8 Torx self-tapping screws



4 Nylon washers



12 Torx nuts



12 Phillips screws (6 x 20 mm)



TOOLS AND SUPPLIES REQUIRED

- #2 Phillips screwdriver
- Flat-tip screwdriver
- Torque wrench
- Shop towel
- T-25 Torx driver
- Long-nose pliers
- T-30 Torx driver
- Hacksaw (32 tpi blade)

INSTALLATION

Customer Information: The information in this installation instruction is intended for use only by skilled technicians who have the proper tools, equipment, and training to correctly and safely add equipment to your vehicle. These procedures should not be attempted by “do-it-yourselfers.”

NOTE:

- The weight of cargo must not exceed the maximum weight capacity: 100 lbs (45 kg).
- Be careful not to damage the roof and other finished surfaces of the body when installing the roof rack.
- Do not interchange the front and rear parts or the right and left parts.

Removing and Cutting the Roof Moldings

1. Place a shop towel under a flat-tip screwdriver, and pry up on the rear end of each roof molding.

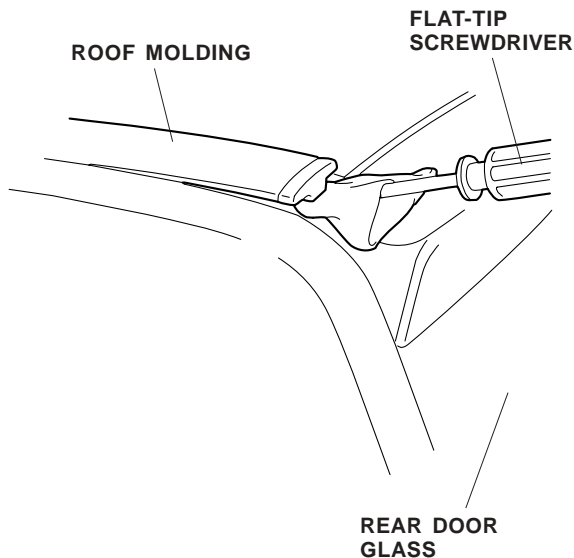

2. Remove the roof moldings by carefully pulling them upward.

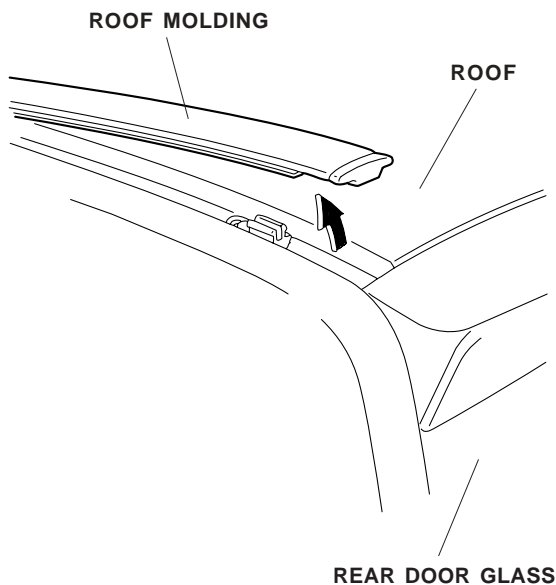

3. Using long-nose pliers, remove the eight retaining clips (four on each side) from the stud bolts. Discard four of the clips.

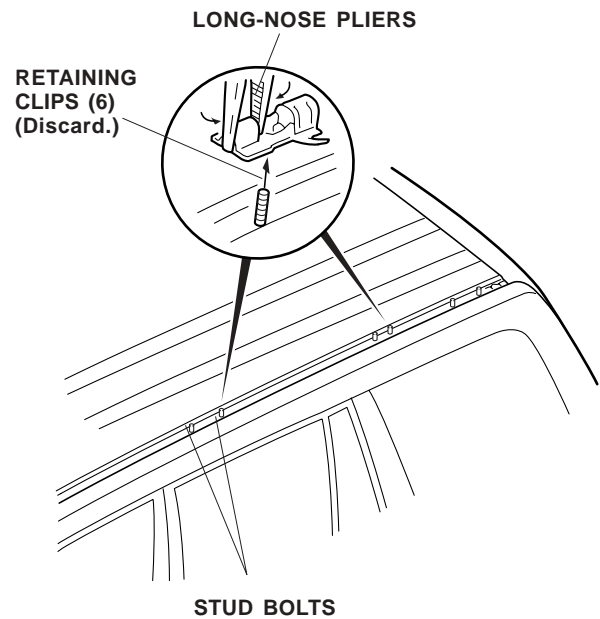

4. Position the adapters (as marked on each adapter) on the roof by aligning the nuts with the studs of the roof as shown. Install the Torx nuts on the studs, and torque them using a T-30 Torx driver to 7 to 10 N-m (5 to 8 lb-ft).

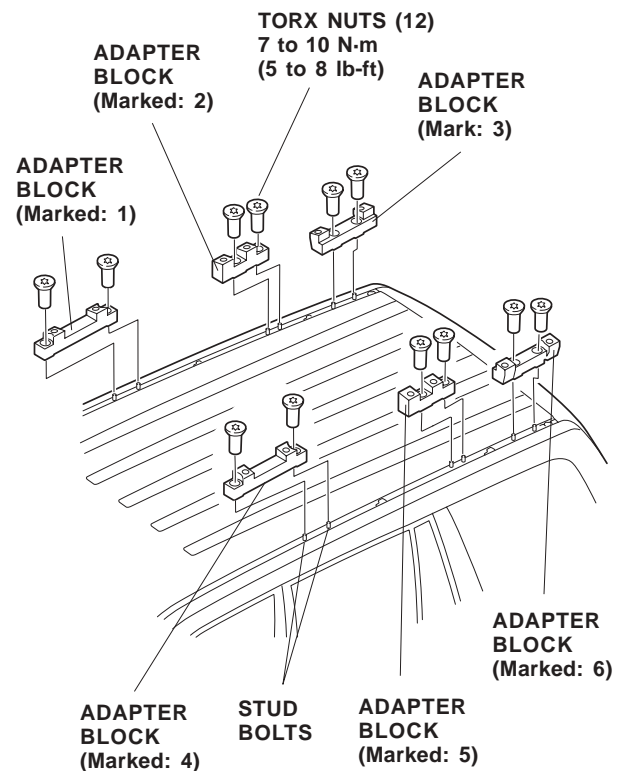

- Using a hacksaw, cut each roof molding according to the dimensions shown. Reinstall the moldings you just cut into the roof gutters.

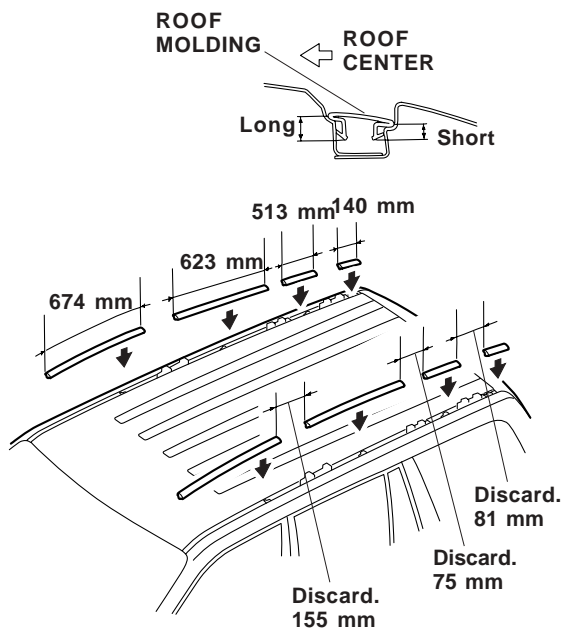

Installing the Roof Rack

- Align the left and right crossbar mounts with the arrow marks. The left side of the crossbar has elongated holes, and the right side has round holes. Also check that all knobs are tightened securely.

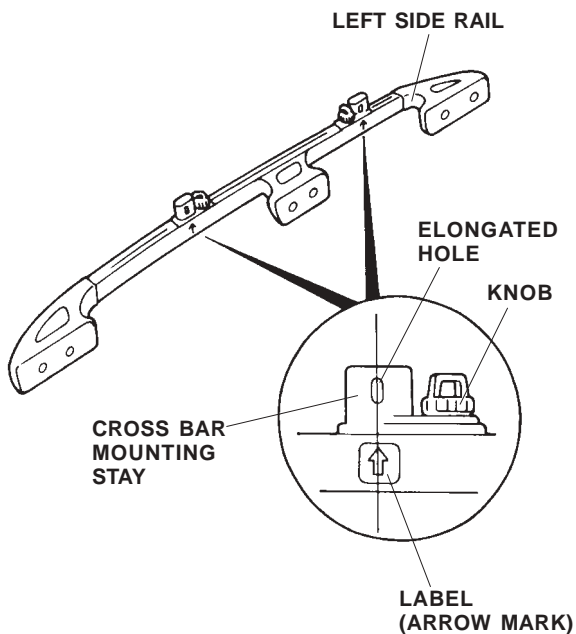

- If any holes are not aligned, loosen the knob and slide the mounting stay until the hole is aligned with the arrow mark. Retighten the knob securely.

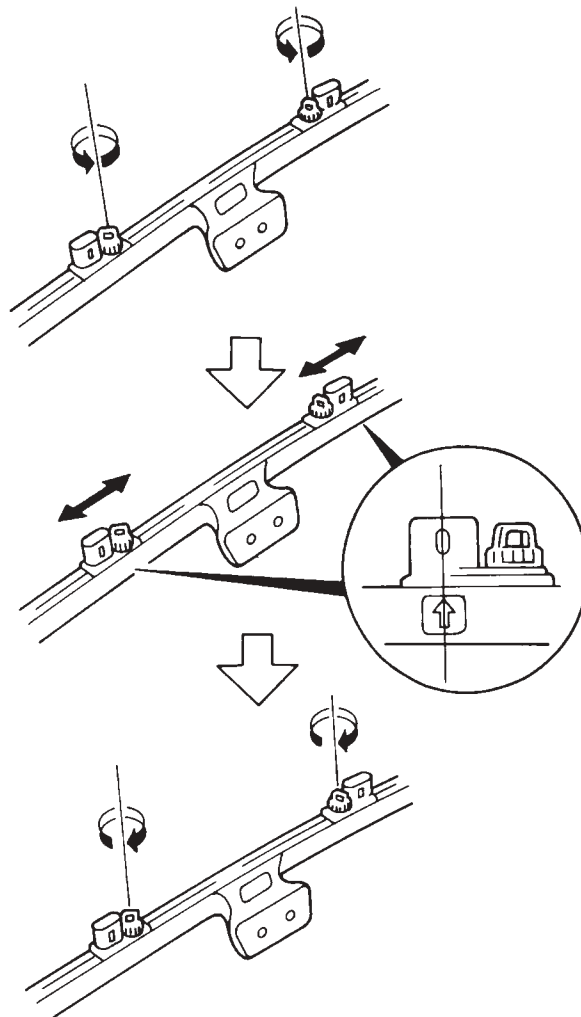

- Insert the crossbars into the right side rail in the direction shown, and install the two Torx self-tapping screws into each side rail. Insert the crossbars into the left side rail and install the two Torx self-tapping screws and nylon washers into each elongated side rail. Tighten all Torx screws securely.

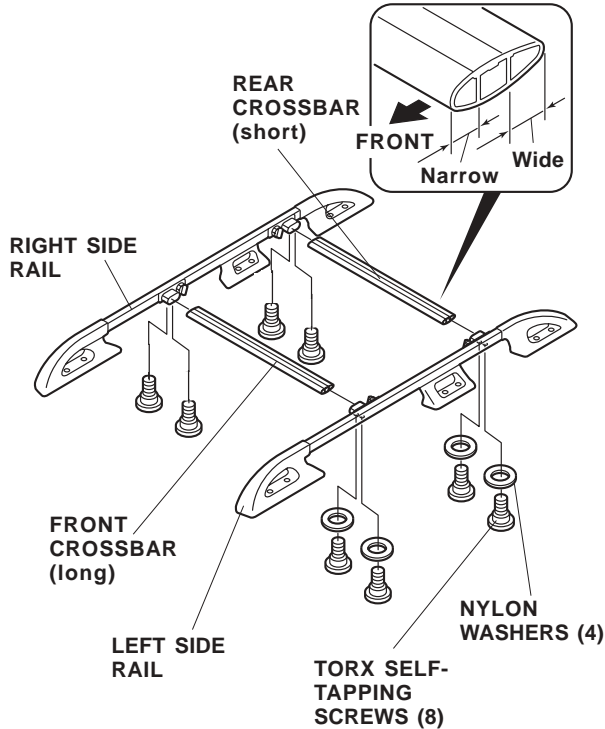

- Place the support pads (as marked on the pads) on the roof over the adapter blocks. Note the directional arrow labeled on each pad.

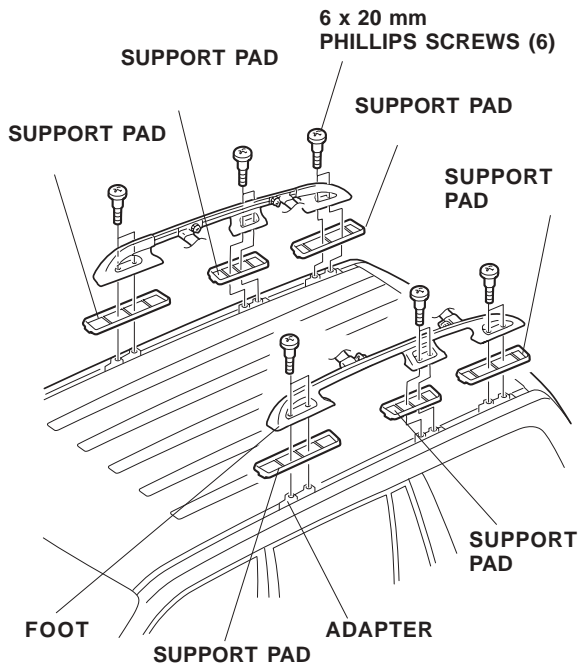

- Set the rack over the support pads and onto the adaptor blocks (short crossbar to the rear), and adjust the left side rail in-or-out until you can install the 12 Phillips screws into each adapter block. Torque the Phillips screws to 7 to 10 N·m (5 to 8 lb-ft).

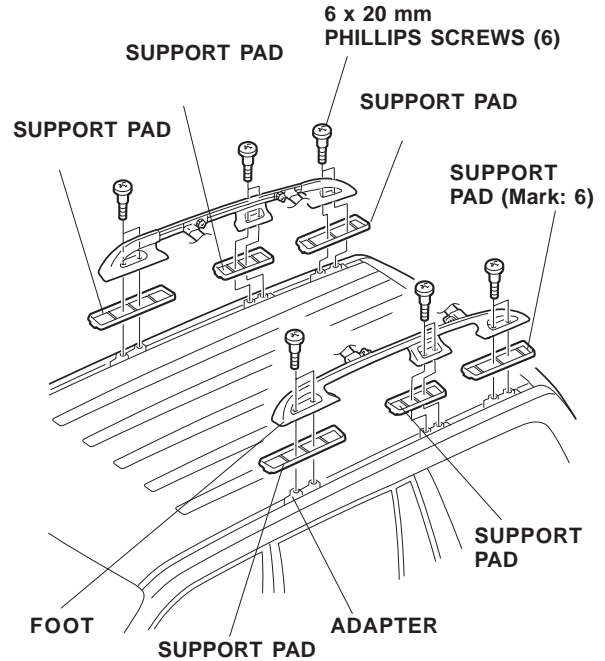

- Rock the roof rack in all directions to check that it is mounted securely without play or rattle.

