



# INSTALLATION INSTRUCTIONS

Accessory  
**CORNER PROTECTORS**  
P/N 08P01-SZA-100A

Application  
**2010 RIDGELINE**

Publications No.  
**All 42132**  
Issue Date  
**AUG 2009**

## PARTS LIST

4 Corner protectors



4 Alcohol swabs

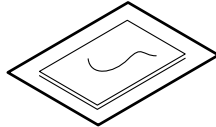

## TOOLS AND SUPPLIES REQUIRED

- Shop towel
- Isopropyl alcohol
- Scale
- Felt-tip pen
- Masking tape
- Rubber roller (T/N MHLE54D)

### Illustration of the Corner Protectors on the Vehicle

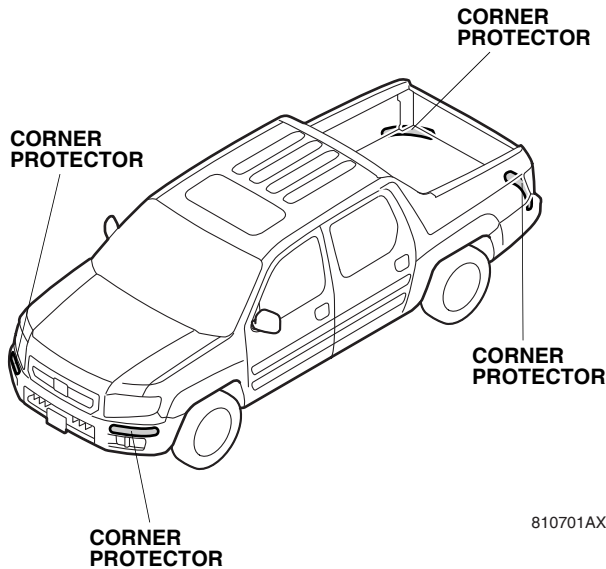

## INSTALLATION

**Customer Information:** The information in this installation instruction is intended for use only by skilled technicians who have the proper tools, equipment, and training to correctly and safely add equipment to your vehicle. These procedures should not be attempted by "do-it-yourselfers."

### NOTE:

- Do not damage the body paint finish.
- This corner protector kit should be installed only if the ambient air temperature is 15°C (60°F) or above. Heat the protectors and bonding surfaces with a heatgun or heat pump if the ambient air temperature is below 15°C (60°F).
- Wash and wax the areas to be covered. Use a high quality paste wax.
- To allow the adhesive to cure, do not wash the vehicle for 24 hours. Please advise the customer.

### Installing the Corner Protectors

1. Using an alcohol swab, thoroughly clean the area on the left side of the front bumper where the corner protector will attach.

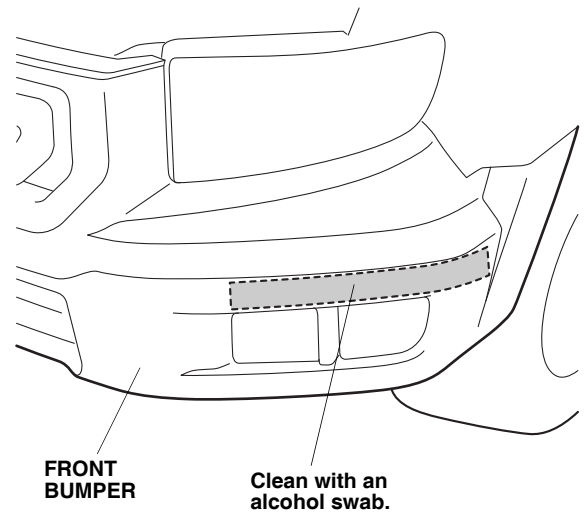

- Using a scale and a felt-tip pen, measure and mark two locations on the front bumper.

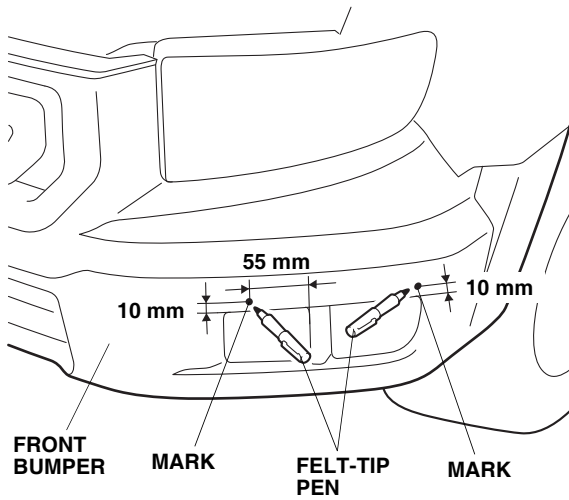

- Align and attach the masking tapes to the marks made on the front bumper.

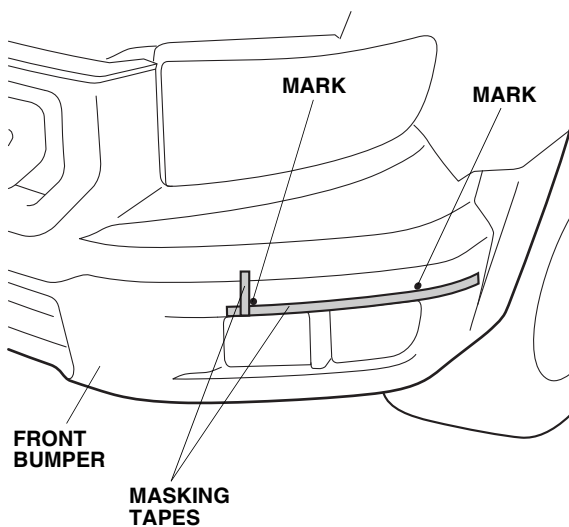

- Erase the marks you made on the front bumper.

- Remove the adhesive backing from the corner protector. Check the back of the corner protector for the correct orientation.

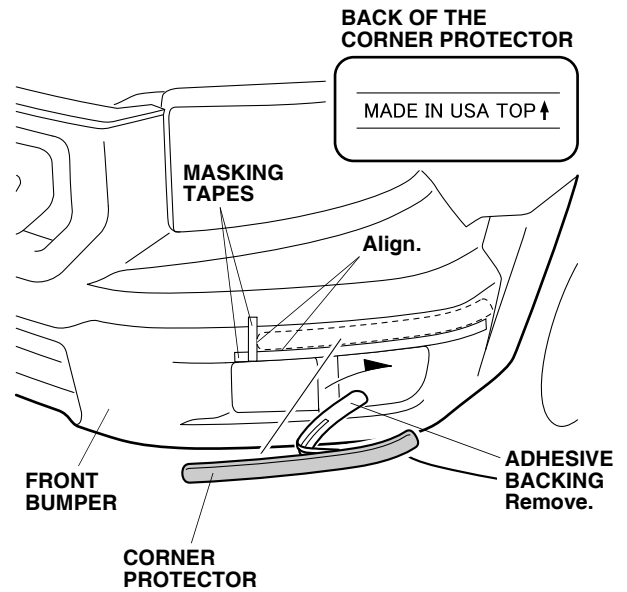

- Attach the corner protector to the front bumper by aligning it with the masking tapes as shown.
- Using a rubber roller, apply pressure against the corner protector and roll from one end to the other.

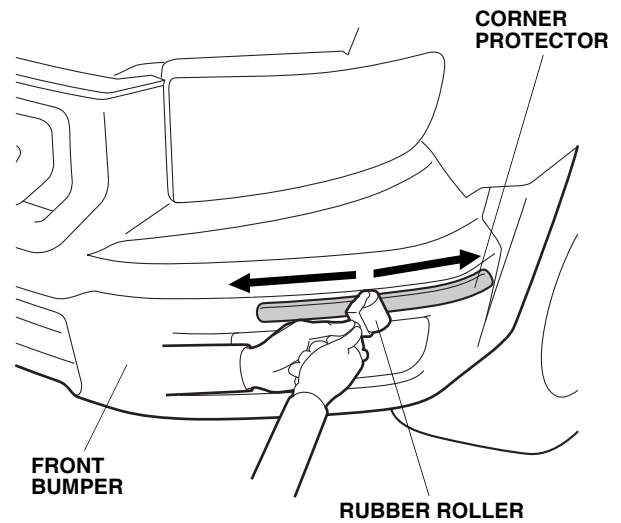

- Repeat steps 1 through 7 on the right side of the vehicle.

- Using an alcohol swab, thoroughly clean the area on the left rear bumper where the corner protector will attach.

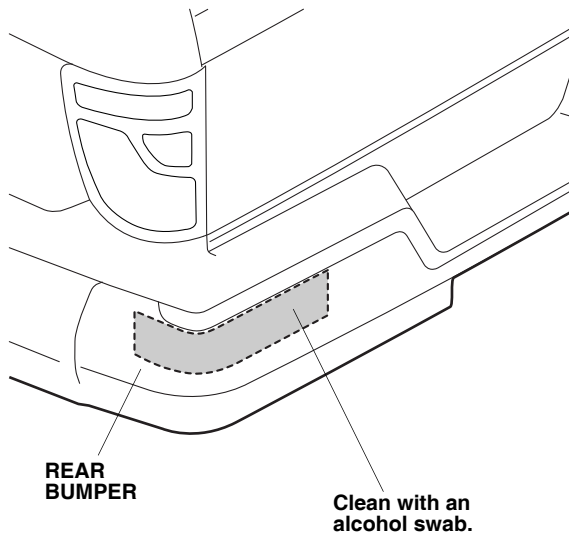

- Using a scale and a felt-tip pen, measure and mark three locations on the rear bumper.

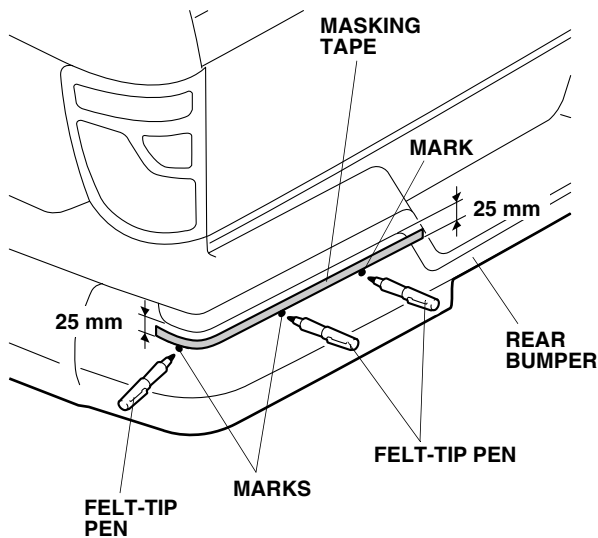

- Align and attach masking tape to the marks made on the rear bumper.

- Attach masking tape at the intersecting point of the seam on the rear bumper and the masking tape attached in step 11.

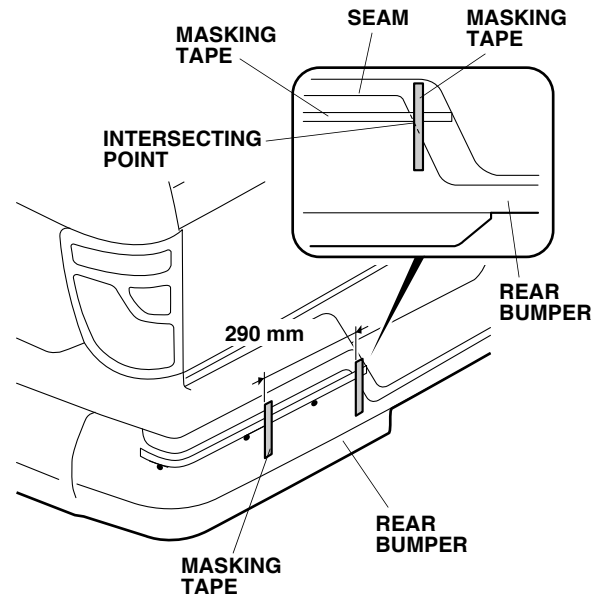

- Measure and attach masking tape on the rear bumper as shown.
- Erase the marks you made on the rear bumper.
- Remove the adhesive backing from the corner protector. Check the back of the corner protector for the correct orientation.

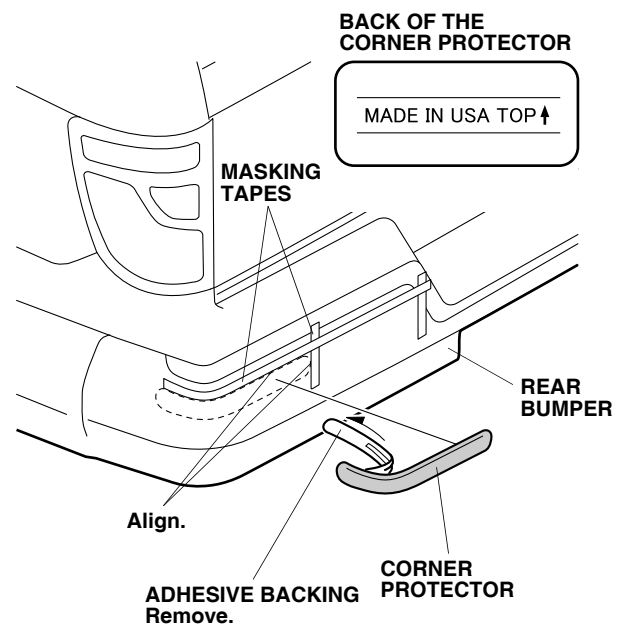

- Attach the corner protector to the rear bumper by aligning it with the masking tapes as shown.

17. Using a rubber roller, apply pressure against the corner protector and roll from one end to the other.

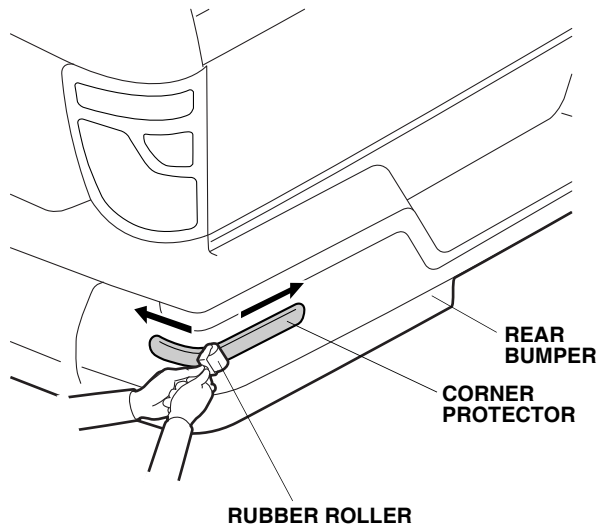

18. Repeat steps 9 through 17 on the right side of the vehicle.