

MULTIMEDIA PLAYER

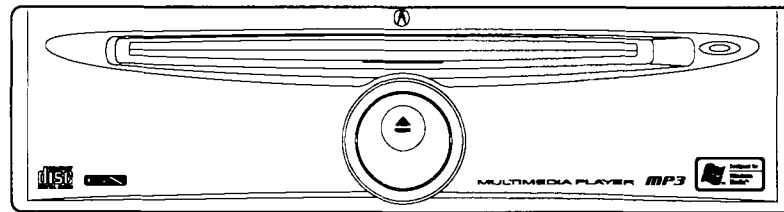

P/N: 08A06-4E2-200

**ACURA**

## ▲ Warning

### ▲ CAUTION

Use of controls or adjustments or performance of procedures other than those specified herein may result in hazardous radiation exposure.

In compliance with Federal Regulations, the followings are reproductions of labels on, or inside the product relating to laser product safety.

KENWOOD CORPORATION  
2967-3, ISHIKAWA-CHO,  
HACHIOJI-SHI  
TOKYO, JAPAN

KENWOOD CORP. CERTIFIES THIS EQUIPMENT  
CONFORMS TO DHHS REGULATIONS NO 21 CFR  
1040.10, CHAPTER 1, SUBCHAPTER J.

**Location : Bottom Panel**

### FCC WARNING

This equipment may generate or use radio frequency energy. Changes or modifications to this equipment may cause harmful interference unless the modifications are expressly approved in the instruction manual. The user could lose the authority to operate this equipment if an *unauthorized change or modification is made.*

### NOTE

This equipment has been tested and found to comply with the limits for a Class B digital device, pursuant to Part 15 of the FCC Rules. These limits are designed to provide reasonable protection against harmful interference in a residential installation. This equipment may cause *harmful interference* to radio communications, if it is not installed and used in accordance with the instructions. However, there is no guarantee that interference will not occur in a particular installation. If this equipment does cause harmful interference to radio or television reception, which can be determined by turning the equipment off and on, the user is encouraged to try to correct the interference by one or more of the following measures:

- Reorient or relocate the receiving antenna.
- Increase the separation between the equipment and receiver.
- Connect the equipment into an outlet on a circuit different from that to which the receiver is connected.
- Consult the dealer or an experienced radio/TV technician for help.

Please write the serial number (on the bottom of the unit) in the space below.  
Keep this booklet as a record of your purchase to help identify the unit if it's stolen.

Serial No. ; \_\_\_\_\_

Precautions.....	4	MP3/WMA Operating Instructions	
Proper Care of Your CDs.....	5	FILE SELECTION .....	10
Notes on Playing MP3/WMA.....	6	FOLDER SELECTION .....	11
Multimedia Player Operation		RANDOM PLAY .....	12
LOADING AND EJECTING CD .....	8	SCAN PLAY .....	13
ILLUMINATION .....	9	In Case of Difficulty.....	14
		Specifications.....	16

## About the instructions of operation

Operate Multimedia Player on the radio unit.  
For basic operations refer to the Owner's Manual of your radio unit.

## Explanation of the hand marks



*Press momentarily.*



3 sec.

*Press and hold for at least 3 seconds.*

# Precautions



**VOLUME**  
For your driving safety, keep the volume low enough to be aware of road and traffic conditions.

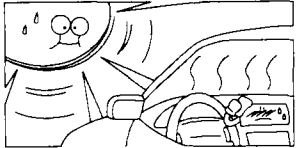

**TEMPERATURE IN THE VEHICLE**  
In order to ensure proper performance, be sure the temperature in your vehicle is between 14°F (-10°C) and 140°F (60°C) before turning your player on. Good air circulation is essential to prevent heat build-up in the unit (especially in hot weather).



**CAR WASHING**  
Do not wash the player, speakers, or CD; moisture can cause electrical shorts or other damage.



**OUTSIDE CLEANING**  
Use a soft cloth to clean the player. Do not use kerosene, thinner or any other type of solvent.

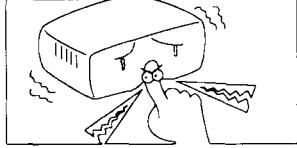

**PRECAUTION FOR OPERATIONS**  
Press the buttons softly when operating the unit. Applying excessive force to the buttons may cause your unit to malfunction.

**Stains, scratches, or warping can cause skipping, malfunction, or low sound quality. Take the following precautions to avoid damage to the compact discs.**

## Handling CDs

- Don't touch the recording surface of the CD.
- CD-R and CD-RW are easier to damage than a normal music CD. Use a CD-R or a CD-RW after reading the caution items on the package etc.
- Don't stick tape etc. on the CD. Also, don't use a disc with tape stuck on it.

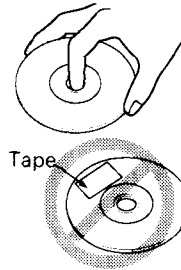

## CD accessories

Don't use disc type accessories.

## When using a new CD

If the CD center hole or outside rim has burrs, use it after removing them with a ball pen etc.

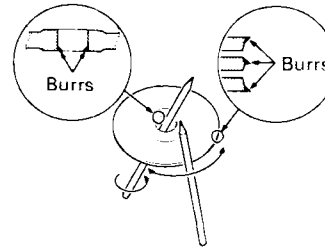

## CD cleaning

Clean from the center of the CD and move outward.

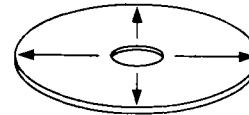

## Removing CDs

When removing CDs from this unit pull them out horizontally.



## CD storage

- Don't place them in direct sunlight (On the seat or dashboard etc.) and where the temperature is high.
- Store CDs in their cases.

## **CAUTION**

## CDs that can't be used

- CDs that aren't round can't be used.

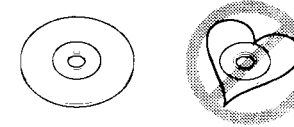

- CDs with coloring on the recording surface or that are dirty can't be used.
- Don't use CD-DAs (normal music CD) without disc mark.  

- A CD-R or CD-RW that hasn't been finalized can't be played. (For the finalization process refer to your CD-R/CD-RW writing software, and your CD-R/CD-RW recorder instruction manual.)

# Notes on Playing MP3/WMA

This unit can play MP3(MPEG1, 2, 2.5 Audio Layer 3) and WMA(Windows Media™ Audio). Note, however, that the MP3/WMA recording media and formats acceptable are limited. When writing MP3/WMA, pay attention to the following restrictions.

## Acceptable media

The MP3/WMA recording media acceptable to this unit are CD-ROM, CD-R, and CD-RW.

When using CD-RW, do full format, not quick format, to prevent malfunction.

## Acceptable medium formats

The following formats are available for the media used in this unit. The maximum number of characters used for file name including the delimiter (".") and three-character extension are indicated in parentheses.

- ISO 9660 Level 1 (12 characters)
- ISO 9660 Level 2 (31 characters)
- Joliet (64 characters)
- Romeo (128 characters)

For a list of available characters, see the instruction manual of the writing software and the section Entering file and folder names below.

The media reproducible on this unit has the following limitations:

- Maximum number of directory levels: 8
- Maximum number of files per folder: 255
- Maximum number of folders: 100

MP3/WMA written in the formats other than the above may not be successfully played.

## Settings for your MP3/WMA encoder and CD writer

Do the following setting when compressing audio data.

- MP3 data with the MP3 encoder
  - Transfer bit rate: 8 — 320 kbps
  - Sampling frequency: 8, 11.025, 12, 16, 22.05, 24, 32, 44.1, 48 kHz

- WMA data with the WMA encoder
  - Transfer bit rate: 48 — 192 kbps
  - Sampling frequency: 32, 44.1, 48 kHz



When you use your CD writer to record MP3/WMA up to the maximum disc capacity, disable additional writing. For recording on an empty disc up to the maximum capacity at once, check Disc at Once.

## Entering file names

The unit recognizes and plays only those MP3/WMA which have the MP3/WMA extension (.MP3/.WMA).

## Writing files into a medium

When a medium containing MP3/WMA data is loaded, the unit checks all the data on the medium. If the medium contains a lot of folders or non-MP3/WMA files, therefore, it takes a long time until the unit starts playing MP3/WMA.

In addition, it may take time for the unit to move to the next MP3/WMA file or a Track Selecting or Folder Selecting may not be performed smoothly.

### NOTE

Loading such a medium may produce loud noise to damage the speakers.

- Do not attempt to play a medium containing a non-MP3/WMA file with the MP3/WMA extension. The unit mistakes non-MP3/WMA files for MP3/WMA data as long as they have the MP3/WMA extension.
- Do not attempt to play a medium containing non MP3/WMA.

## MP3/WMA playing order

When selected for play, Folder Selection, or Track Selection, files and folders are accessed in the order in which they were written by the CD writer.

Because of this, the order in which they are expected to be played may not match the order in which they are actually played. You may be able to set the order in which MP3/WMA are to be played by writing them onto a medium such as a CD-R with their file names beginning with play sequence numbers such as "01" to "99", depending on your CD writer.

For example, a medium with the following folder/ file hierarchy is subject to Folder Selecting, or Track Selecting as shown below.

Example of a medium's folder/file hierarchy

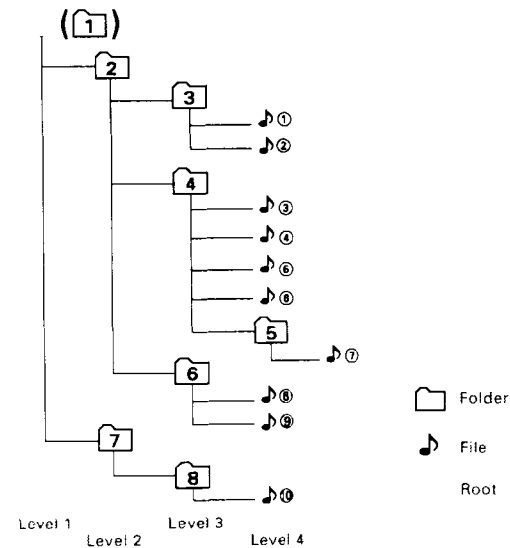

When a Track Selection is executed with file 4 being played ...

Current file number	Operation of the button	
	⏮ (Track Down) Button	⏭ (Track Up) Button
4	Beginning of file  4 •  5 •  6 •  7 •  8	3 •  2 •  1 •  8

When an Folder Selection is executed with file 4 being played ...

Current folder number	Operation of the button	
	DISC- (Disc Down) Button	DISC+ (Disc Up) Button
4	3 • 2 • 1 • 8 ...	5 • 6 • 7 • 8 • 1 ...

## About displays in the radio unit

- If playing time is more than 100 minutes, only last two digits are displayed.
- If the folder number is 100, "00" is displayed.
- Information on file names, tags, etc. cannot be displayed.

### NOTE

Folder numbers may not be displayed depending on radio units.

## Displaying files that cannot be played

If an MP3/WMA file that cannot be played is played, the DISC indicator blinks to show the unavailability.

- A copy-protected WMA file is played. (DRM : Digital Rights Management)
- A MP3/WMA is played with a format that this unit can't support.

# Multimedia Player Operation

## LOADING AND EJECTING CD

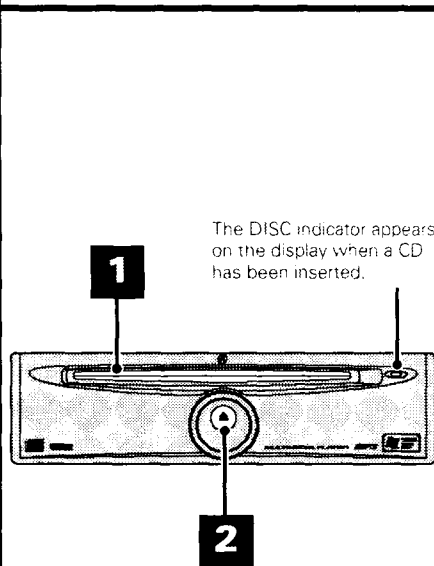

1

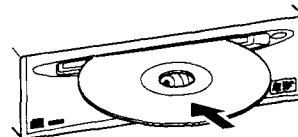

2



### To play

**Insert compact disc in the slot with the label facing up.**

The CD will start playing.

### NOTE

- Do not attempt to insert a CD into the slot if another one is already there.
- If an MP3/WMA file that cannot be played is played, the DISC indicator blinks to show the unavailability.
  - A copy-protected WMA file is played. (DRM : Digital Rights Management)
  - A MP3/WMA is played with a format that this unit can't support.

### To stop and eject

**Press the ▲(EJECT) button.**

The CD will eject.



## ILLUMINATION

*The illumination is linked with the car's illumination control the illumination color between white and amber.*



**1**



**3 sec.**

### To switch the illumination color

**Press the ▲(EJECT) button for at least three seconds.**

Each press of a button alternates the illumination color as show below.

White ↔ Amber

#### **NOTE**

Illumination colors cannot be switched during ACC being OFF.

# MP3/WMA Operating Instructions

## FILE SELECTION

*Searching for a file in the folder.*

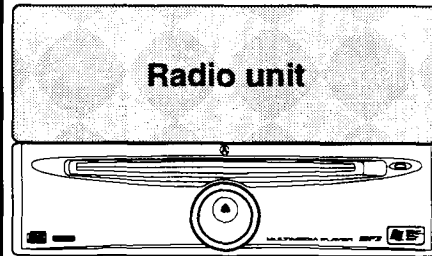

**1**



Track Up

### Forward file skip

**Press the Track Up button on the radio unit.**  
Each time the button is pressed a file switches to the next file in the folder.

**2**



Track Down

### Backward file skip

**Press the Track Down button on the radio unit.**  
If the button is pressed once, the beginning of the current file is found. Then, each time the button is pressed a file switches to the previous file in the folder.

## FOLDER SELECTION

*Selecting the folder you want to hear.*

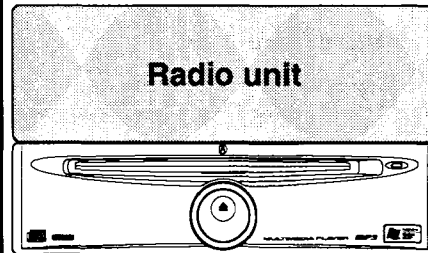

**1**

**Disc+**

Disc Up

### Forward folder skip

**Press the Disc Up button on the radio unit.**

Pressing the button moves to the next folder. The unit plays the medium starts at the beginning of the selected folder.

#### **NOTE**

If the selected folder contains no MP3/WMA file, the unit automatically plays the file nearest to that folder in the MP3/WMA file playing order.

**2**

**Disc-**





Disc Down

### Backward folder skip

**Press the Disc Down button on the radio unit.**

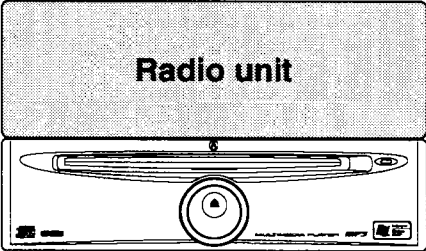
Pressing the button moves back to the previous folder. The unit plays the medium starts at the beginning of the selected folder.

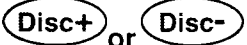
# MP3/WMA Operating Instructions

RANDOM PLAY		<i>Play all the files on the current folder in random order.</i>
	<b>1</b>  Random On	<b>To start random play</b> <b>Enabling the Random function on the radio unit.</b> Selecting files in random order to be played. <b>NOTE</b> When all the files on a certain folder have been played using random play, the next folder will start playing using the same function.
	<b>2</b>  Track Up	<b>To select another file</b> <b>Press the Track Up button on the radio unit.</b> The player will randomly choose another file in the folder.
	<b>3</b>  Disc Up or Disc Down	<b>To change folder</b> <b>Press the Disc Up or Disc Down button on the radio unit.</b> Each time the button is pressed folders switch in sequence to continue Random Play.
	<b>4</b>  Random Off	<b>To cancel random play</b> <b>Disabling the Random function on the radio unit.</b> Random play will be canceled and normal play will resume.

## SCAN PLAY

*Playing the first part of each file in folder you are listening to and searching for the file you want to listen to.*

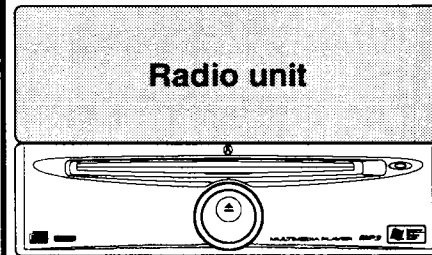

**1**

**SCN**  
Scan On

### To start scan play

**Enabling the Scan function on the radio unit.**  
The first 10 seconds of each file is played in sequence.

**2**

**SCN**  
Scan Off

### To cancel scan play

**Disabling the Scan function on the radio unit.**  
Scan play will be canceled and normal play will resume.

#### **NOTE**

When all files in the folder you are listening to are scanned, the scan play is canceled.

# In Case of Difficulty

If you encounter a problem, please review the items in the guide. This guide will help you isolate the problem if the player is at fault. Otherwise, make sure the rest of your system is properly connected or consult your authorized Acura dealer.

## CD source

Symptom	Cause	Remedy
A CD ejects as soon as it is loaded.	The CD is upside-down.	Load the CD with the labeled side up.
	The CD is quite dirty.	Clean the CD, referring to the section on "Disc cleaning" (refer to page 5).
	Disc not centered on clamping mechanism. ④	Disc center hole defective, preventing table of contents (TOC) to be read, triggering the eject mechanism.
The CD won't insert.	The CD is quite burrs ⑤.	Remove burrs of CD, referring to the section on "When using a new disc" (refer to page 5).
The sound skips on a CD.	The CD is scratched ② or dirty ①.	Clean the CD, referring to the section on "Disc cleaning" (refer to page 5).
	Pinholes in disc caused during stamping process or reflective material missing ③.	Check for pinholes by holding disc up to a light source and looking at it as illustrated ⑥.
A track will not play.	Random play has been selected.	Turn off random play.
Cannot play CD-R or CD-RW.	Finalization process is not being conducted for CD-R/CD-RW.	Conduct finalization process with CD recorder.

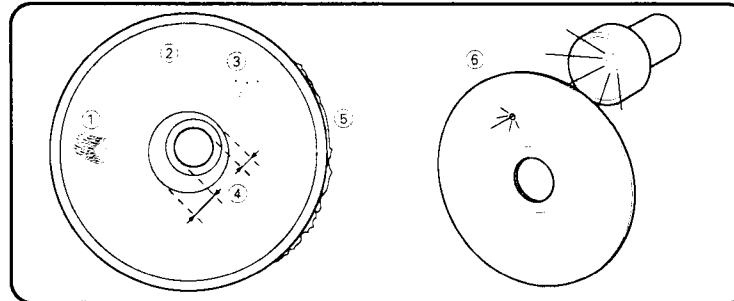

## MP3/WMA source

Symptom	Cause	Remedy
Cannot play an MP3/WMA.	Not conforming to ISO 9660 Level 1/2, Joliet, and Romeo	Use a medium conforming to ISO 9660 Level 1/2, Joliet, and Romeo.
	The MP3/WMA has no or invalid file name extension.	Add the ".MP3/.WMA" extension to the MP3/WMA file name.
	The media is scratched or dirty.	Clean the media, referring to the section on "Disc cleaning" (refer to page 5).
	A copy-protected WMA file is played. (DRM)	Copyrighted WMA files cannot be played.
Noise or no sound generated when an MP3/WMA is played.	The file has the MP3/WMA file name extension while it is not an MP3/WMA.	Do not use the ".MP3/.WMA" extension in non-MP3/WMA.
Takes time before the unit starts playing MP3/WMA.	The medium contains many folders, files, and hierarchical levels.	The unit checks all files on the loaded medium first. If the medium has many files recorded, it may take a long time for the unit before it starts playing MP3/WMA.
Fails to play MP3/WMA in the intended order.	The MP3/WMA tracks were not written by the CD writer in the order in which you wanted them to be played.	Depending on the CD writer, you may be able to set the order in which MP3/WMA tracks are to be played by writing them onto a medium with their track names beginning with play sequence numbers such as "01" to "99".
The sound skips when an MP3/WMA is being played.	The media is scratched or dirty.	Clean the media, referring to the section on "Disc cleaning" (refer to page 5).
	The recording condition is bad.	Record the media again or use another media.
The songs in the selected folder aren't played in Folder selection.	There are no MP3/WMA in the selected folder.	Make sure there's recorded content in the MP3/WMA media.
The MP3/WMA track/folder selection takes time.	Many tracks are recorded on the media.	When the media directory is complex, the track/folder selection can take time.
The MP3/WMA track time isn't displayed correctly.	--	There are times when it isn't displayed correctly according to the MP3/WMA recording conditions.

## Specifications

### Player Section

Laser Diode .....	GaAlAs ( $\lambda=780$ nm)
Digital Filter (D/A) .....	8 Times Over Sampling
D/A Converter .....	1 bit
Spindle speed .....	1000 – 400 rpm (CLV 2times)
Wow & Flutter .....	Below Measurable Limit
Frequency response ( $\pm 1$ dB) .....	20 Hz – 20 kHz
Total harmonic distortion (1 kHz) .....	0.01 %
Signal to Noise ratio (1 kHz) .....	90 dB
Dynamic range .....	90 dB
Stereo separation .....	80 dB
MP3 decode .....	Compliant with MPEG-1.0/2.0/2.5 Audio Layer-3
WMA decode .....	Compliant with Windows Media™ Audio

### General

Supply voltage .....	13.2 V DC (negative earth)
Maximum current .....	1.5 A (operating) 1.5 mA (standby)
Dimensions (width × length × depth) .....	180 × 50 × 155 mm 7-1/16 × 2 × 6-1/8 inch
Weight .....	2.31 lbs (1.05 kg)

Specifications subject to change without notice.

# ACURA

© American Honda Motor Co., Inc. 2002 All rights Reserved.

08A06-4E2-2000-81  
B64-2340-00  
Printed in Japan